

ADHESIVE BONDING OF WOOD

Technical Bulletin No. 1512

August 1975

U.S. Department of Agriculture

Forest Service

ADHESIVE BONDING OF WOOD

By
**M. L. Selbo, retired, formerly Chemical Engineer,
Forest Products Laboratory-Forest Service
U.S. Department of Agriculture**

Technical Bulletin No. 1512

Washington, D. C.

August 1975

Selbo, M. L.

1975. Adhesive bonding of wood. U.S. Dep. Agr., Tech. Bull. No. 1512,
p. 124.

Summarizes current information on bonding wood into dependable, long-lasting products. Characteristics of wood that affect gluing are detailed, as well as types of adhesives and processes to be used for various conditions.

KEY WORDS; Bonding wood; adhesives; glues; glue types; glued products; gluing techniques; glulam.

Oxford No. 824.8

For sale by the Superintendent of Documents, U.S. Government Printing Office,
Washington, D.C., 20402. Price \$1.55. Stock No. 001-000-03382

FOREWORD

More than four decades ago Thomas R. Truax wrote USDA Bulletin No. 1500, "Gluing of Wood." In this bulletin, Truax laid down sound principles that have stood the critical tests of time.

But adhesive technology has expanded enormously and there are many building blocks to be added to the solid foundation Truax laid down in the 1920's.

When Truax' bulletin was published, synthetic adhesives had not been introduced and practically all wood gluing was done with glues formulated or compounded from naturally occurring materials. Some of these glues (based on casein, blood, starch, and animal extracts) are still being used, but in quantities far overshadowed by synthetics such as phenol-, resorcinol-, urea-, and melamine-formaldehyde resins, as well as vinyl resins of various types.

Furniture was the major glued wood product when Truax wrote his technical bulletin; softwood plywood, suitable only for interior use, was in its infancy. Currently, gluing is involved in practically all branches of the wood-using industry. In housing, gluing is employed extensively, particularly in prefabrication, but also on the building site; plywood is mass produced in more than half of the States of the Union. Structural laminated timbers are produced for spans well over 300 feet and for structures as divergent as churches and minesweepers.

The technology of adhesives and gluing has come a long way. With some synthetic resins, joints can be produced that withstand the ravages of the elements fully as well as wood itself.

ACKNOWLEDGMENT

The author appreciates the cooperation of gluing firms, associations, and equipment suppliers in providing photographs and granting permission to Publish them. Photographs were Provided by Rilco Laminated Products; Industrial Woodworking Machine Company; American Plywood Association; Ashdee Division, George Koch Sons, Inc.; Carter Products Company, Inc.; Chas. Smith Enterprises, Inc.; Newman Machine Company; James L. Taylor Manufacturing Company; Evans Division, Royal Industries; Globe Machine Manufacturing Company, Inc.; Black Brothers; and Töreboda Limträ (Sweden).

Use of trade, firm, or corporation names in this publication is for the information and convenience of the reader. Such use does not constitute an official endorsement or approval of any product or service by the U.S. Department of Agriculture to the exclusion of others that may be suitable.

Mention of a chemical in this publication does not constitute a recommendation; only those chemicals registered by the U.S. Environmental Protection Agency may be recommended, and then only for uses as prescribed in the registration-and in the manner and at the concentration prescribed. The list of registered chemicals varies from time to time; prospective users, therefore, should get current information on registration status from Pesticides Regulation Division, Environmental Protection Agency, Washington, D.C. 20460.

Requests for copies of illustrations contained in this publication should be directed to the Forest Products Laboratory, USDA Forest Service, P.O. Box 5130, Madison, Wis. 53705.

CONTENTS

	<i>Page</i>
Introduction	1
Wood Properties Important in Adhesive Bonding	4
Density	4
Shrinking and Swelling	7
Adhesives for Wood	10
Synthetic Adhesives	10
Adhesives of Natural Origin	27
Improving Performance of Wood Through Gluing	35
Crossbanded Construction	36
Laminated Construction	45
End and Corner Joint Construction	49
Preparing Wood for Gluing	56
Moisture Content	56
Drying and Conditioning	58
Storage Before Gluing	59
Surfacing Wood For Gluing	60
Machining Special Types of Joints	61
Cutting and Preparing Veneer	62
Adhesives and Bonding Processes for Various products	65
Plywood	65
Laminated Timbers	69
Furniture	70
Ship and Boat Construction	76
Doors	77
Sporting Goods	81
Particleboard	81
Housing and Housing Components	82
New Products	84
Gluing Operation	87
Mixing Adhesive	87
Spreading Adhesive	88
Assembling Parts	90
Assembly Time	90
Pressing or Clamping	91
Curing Adhesive	92
Conditioning Glued Products	96
Adjustments in Adhesives and Gluing procedures	96
Gluing Treated Wood	98
Wood Treated With Oil-Soluble Preservatives	101
Wood Treated With Waterborne Preservatives	101
Wood Treated With Fire-Retardant Chemicals	101
Quality Control	102
Glossary	109
Index	120

ADHESIVE BONDING OF WOOD

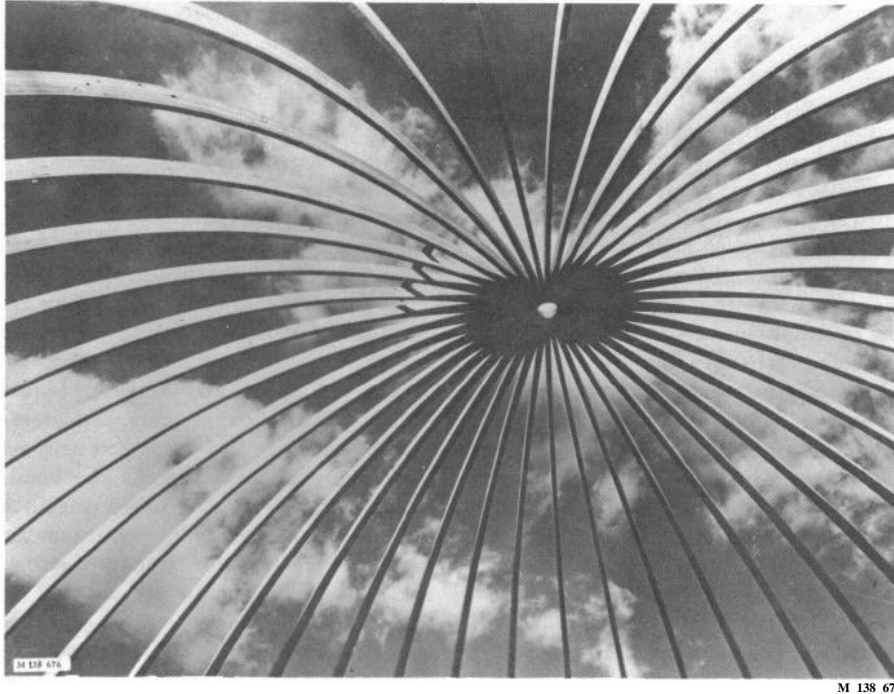

Figure 1.—These glued-laminated beams stretching skyward are but one striking example of today's profitable partnership between wood and adhesives. Soon these beams will hold up the roof of a sports arena.

INTRODUCTION

Bonding of wood with glue is known to date back to the Pharoahs and in all likelihood the first use of glue with wood was much further back in antiquity. Since then, glued wood products have become

common (fig. 1)—but the gluing process has never become static.

This publication brings together current information on use of adhesives for bonding wood, so it can serve as a guide

in production of more dependable glued products. The more important types are emphasized because new synthetics are appearing almost daily and to discuss all synthetic and "natural" adhesives would be an impractical and almost impossible task.

The information presented here is based on research carried out at the Forest Products Laboratory and elsewhere, as well as on the author's experience both in research and production gluing. A list of selected references follows each major section.

Factors that affect the adequacy of the glue bonds are emphasized, rather than theories of adhesive bonding which, unfortunately, still remain in a somewhat nebulous state. Even the world-famous scientist Debye¹ steps lightly when approaching the subject of adhesion: "The forces between two molecules are supposed to consist of a universal attraction, which increases with diminishing distance until the two molecules touch."

Blomquist¹ states that ". . . the actual adhesion is *more probably* due to chemical or physical forces . . ." and "Adhesion is assumed first to require actual wetting of the adherend by the adhesive. . . ."

There seems to be general agreement that a prime prerequisite for good bonding is that the adhesive must wet the surfaces to be joined. A related example is that water generally *wets* clean, freshly machined wood surfaces and also forms strong

bonds between them when cooled to freezing temperatures. So, an adhesive apparently must "wet" wood surfaces and subsequently solidify to make a strong bonded joint.

Putting a drop of water on wood and observing the rate at which it is absorbed has been proposed as a test for gluability. This theory holds in most cases; however, there are exceptions such as southern pine treated with creosote to an 8 pounds per cubic foot retention. Actually the pine was glued adequately to serve more than 25 years in bridge stringers, yet the oily creosote certainly would have made the water absorption test misleading.

One of the more successful attempts to explain adhesive bonding of wood was made in 1929 when Truax,¹ Browne, and Brouse discussed the theories of mechanical and specific adhesion. Further theoretical clarification undoubtedly will evolve. But in the meantime, some practical engineering principles must be applied to assure dependability in glue joints.

It is well known that numerous factors (such as pressure, temperature, and assembly time) play an important part at some time during the formation of a glue bond. If these factors are controlled within a reasonable range about the optimum for each, high-quality glue bonds will result. But if borderline conditions are used for one or more of these factors—in other words, if no substantial factors of safety are employed—then the end results can be catastrophic. Also, since the interactions between the various factors are often ill-defined, aiming toward optimum conditions is the safest practice.

In figure 2, good results are indicated by the flat (horizontal) portion of the curve and decreasing joint quality by the downward sloping part at left. Under laboratory conditions good results can consistently be obtained even when operating near the breaking point of the curve. In plant production, the control of the factors is usually less exact and variable results may

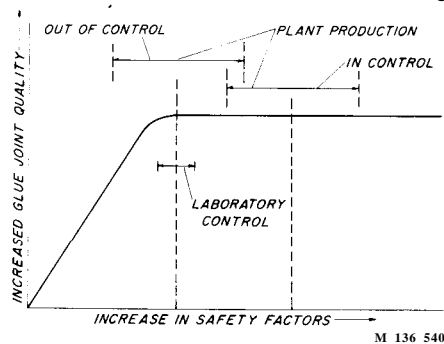

Figure 2.—Gluing variables require more control in plant production than might be indicated from laboratory experiments.

¹See reference on Page 3.

occur (indicated as out of control on the figure), unless greater margins of safety are allowed.

In bonding wood with adhesives one must be aware that wood is not a uniform substance, but a complex material that varies significantly in many properties—density, for instance, which may range from lower than 0.30 to higher than 0.80—and it would be mere chance if the same bonding material and procedure would be suitable for the entire range of wood species.

Use of adhesives for bonding wood has increased enormously over the past decades and glued products vary in size from tiny wood jewelry to giant laminated timbers spanning hundreds of feet. No single adhesive has ever been formulated, and probably none ever will be, that will meet the various requirements of all the innumerable applications of adhesive bonding. It is therefore important that the user has the proper background information to choose and evaluate the adhesive best suited for a particular application.

During the more than 30 years the author has been involved in wood gluing—in plywood production, industry adhesive research, and Government research on adhesives and glued products—great changes and progress have occurred in this field. The plywood industry, by far the largest user of wood adhesives, has grown to become an extremely important factor in the construction field. The structural laminating industry has also shown a healthy growth as improved glues and design information have become available. Adhesives for furniture have shifted more and more from those based on the natural-occurring materials to synthetics. The bonding of wood with adhesives—generally far more efficient than the use of mechanical fasteners—has made possible a wide range of products and uses for which wood was considered unsuitable a few short decades ago.

Adhesives available today cover a wide area in properties and performance characteristics, and the producer of glued wood products must be keenly aware of these facts when switching from one wood species to another, from one adhesive to another, and from one product to another.

In general, the serviceability of a glued wood assembly depends upon (1) the kind of wood and its preparation for use, (2) the type and quality of the adhesive, (3) compatibility of the gluing process with the wood and adhesive used, (4) type of joint or assembly, and (5) moisture-excluding effectiveness of the finish or protective treatment applied to the glued product. In addition, conditions in use naturally affect the performance of a glue bond. For adequate performance, a glue joint should remain as strong as the wood under the service conditions to which the glued product is exposed. If it does not, it becomes the weakest link in the assembly and the point at which failure first will occur.

SELECTED REFERENCES

- Blomquist, Richard F.
1963. Adhesives—past, present, and future. Edgar Marburg Lect., Am. Soc. Test. Mater., Philadelphia, Pa. 34 p.
- Browne, Fred L. and Brouse, Don
1929. Nature of adhesion between glue and wood. *Ind. and Eng. Chem.* 21:80-84. Jan.
- Debye, P.J. W.
1962. Interatomic and intermolecular forces in adhesion and cohesion. *In Adhesion and Cohesion*, edited by Philip Weiss, p. 1-17. Elsevier Publ. Co., New York
- Truax, Thomas R.
1929. The gluing of wood. *USDA Bull.* No. 1500. 78 p.
- U.S. Forest Products Laboratory, Forest Service
1974. Wood handbook: Wood as an engineering material. U.S. Dep. Agric., *Agric. Handb.* 72, rev., 432 p.

WOOD PROPERTIES IMPORTANT IN ADHESIVE BONDING

Various properties of wood affect its gluing characteristics. Perhaps the most important is wood's density, but the amount of shrinking and swelling with changes in moisture content is also an important factor, particularly where long-term serviceability of glue joints is required. In certain cases, pitch content, oiliness, and the presence of other exudation products and extractives also have some influence on gluability.

DENSITY

Two blocks of wood of equal volume may vary a great deal in weight, even if the blocks are of the same species. Weight of wood is generally expressed either in pounds per cubic foot or as a comparison with the weight of an equal volume of water (specific gravity, or sp. g.).

Table 1 shows the great range in specific gravity among a number of the more important commercial species of the United States. In general, strength properties of wood increase with specific gravity. In a

*Table 1.—Range in specific gravity values¹
of some common species of wood*

Species	Sp. g.
Hickories (<i>Carya</i> sp.):	
Pignut (<i>C. glabra</i>).....	.66
Shagbark (<i>C. ovata</i>).....	.64
Shellbark (<i>C. laciniosa</i>).....	.62
Pecan (<i>C. illinoensis</i>).....	.60
White oak (<i>Quercus</i> sp.):	
White (<i>Q. alba</i>).....	.60
Chestnut (<i>Q. prinus</i>).....	.57
Overcup.....	.57
Red oak (<i>Quercus</i> sp.):	
Cherrybark (<i>Q. falcata</i> var. pagodaefolia).....	.61
Northern red (<i>Q. rubra</i>).....	.56
Southern red (<i>Q. falcata</i>).....	.52

*Table 1.—Range in specific gravity values¹
of some common species of wood (continued)*

Species	Sp. g.
Maple (<i>Acer</i> sp.):	
Sugar (<i>A. saccharum</i>).....	.56
Black (<i>A. nigrum</i>).....	.52
Red (<i>A. rubrum</i>).....	.49
Silver (<i>A. saccharinum</i>).....	.44
Birch, yellow (<i>Betula alleghaniensis</i>).....	.55
Ash, white (<i>Fraxinus americana</i>).....	.55
Pine (<i>Pinus</i> sp.):	
Longleaf (<i>P. palustris</i>).....	.54
Loblolly (<i>P. taeda</i>).....	.47
Shortleaf (<i>P. echinata</i>).....	.47
Ponderosa (<i>P. ponderosa</i>).....	.38
Eastern white (<i>P. strobus</i>).....	.34
Sugar (<i>P. lambertiana</i>).....	.34
Elm, American (<i>Ulmus americana</i>).....	.46
Larch, western.....	.48
Tupelo, black (<i>Nyssa sylvatica</i>).....	.46
Sweetgum (<i>Liquidambar styraciflua</i>).....	.46
Douglas-fir, Coast (<i>Pseudotsuga menziesii</i> var. <i>menziesii</i>).....	
	.45
Hemlock, western (<i>Tsuga heterophylla</i>).....	.42
Yellow-poplar (<i>Liriodendron tulipifera</i>).....	.40
Fir (<i>Abies</i> sp.):	
Pacific silver (<i>A. amabilis</i>).....	.40
White (<i>A. concolor</i>).....	.37
California red (<i>A. magnifica</i>).....	.36
Spruce (<i>Picea</i> sp.):	
Sitka (<i>P. sitchensis</i>).....	.37
Engelmann (<i>P. engelmannii</i>).....	.33
Alder, red (<i>Alnus rubra</i>).....	.37
Cottonwood, eastern (<i>Populus deltoides</i>).....	.37
Aspen, quaking (<i>Populus tremuloides</i>).....	.35
Redwood, young growth (<i>Sequoia</i> <i>sempervirens</i>).....	
	.34
Balsam poplar (<i>Populus balsamifera</i>).....	.31
Cedar, Northern white- (<i>Thuja</i> <i>occidentalis</i>).....	
	.29

¹From 1974 Wood Handbook. Specific gravity values are based on oven-dry weight and green volume.

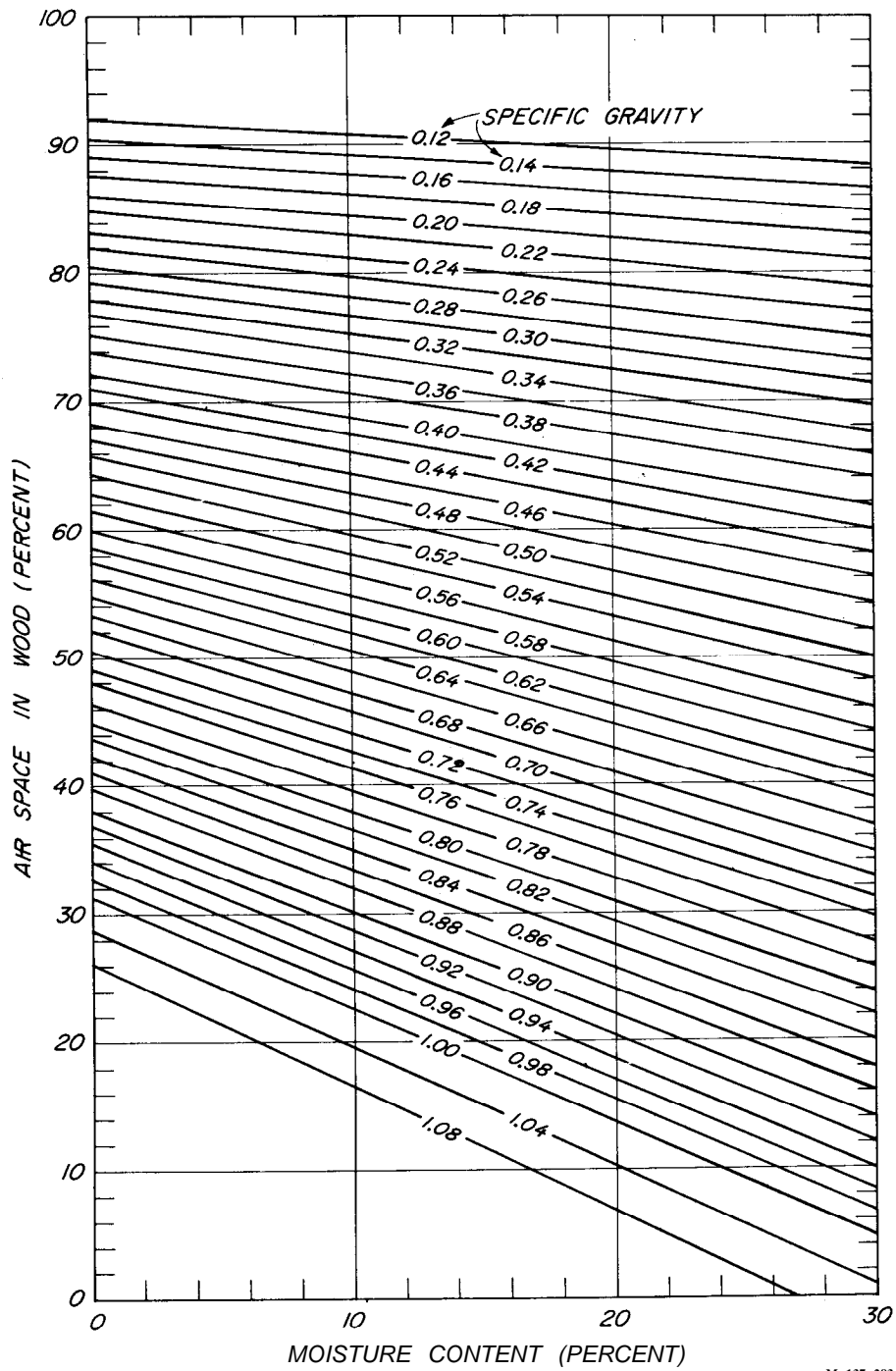

M 137 283

Figure 3.—Relation between air space in wood and specific gravity at various moisture contents.

similar manner, the glue-bond quality required for a dense species is greater than for a lighter one. Hence, the chart indicates the relative glue-bond quality required for the species listed and for other species falling within the density range given.

The solid wood substance of all species has about the same specific gravity (1.45), but in high-density species less of the volume in the capillary structure of dry wood is occupied by air. As moisture is added to the wood, the air space decreases (fig. 3).

When wood of different species is examined with the naked eye, the ratio of wood substance to air space is not readily seen. Under the microscope, the difference in such characteristics as cell wall thickness, cell diameters, and pore space is easily noticed. Figures 4 to 8 are photomicrographs of species covering a wide range in these characteristics. The same magnification is used for each photo.

The enlarged cross section of western redcedar (fig. 4) shows that slightly more

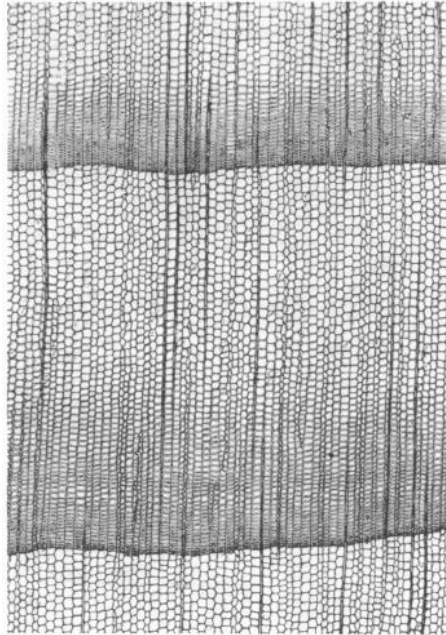

M 139 603

Figure 4.—Cross section of western redcedar, 33× (wood substance about 22 pct. and air space 78 pct.).

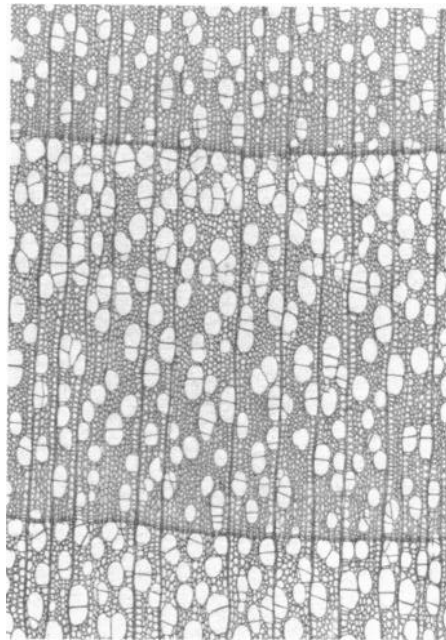

M 139 600

Figure 5.—Aspen (quaking), 33× (wood substance about 27 pct. and air space 73 pct.).

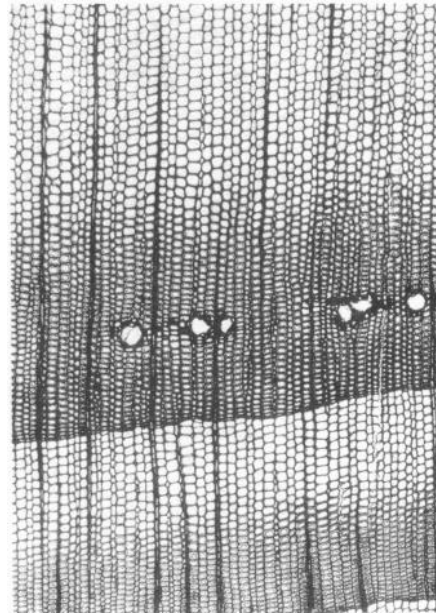

M 139 602

Figure 6.—Douglas-fir, 33× (wood substance about 32 pct. and air space 68 pct.).

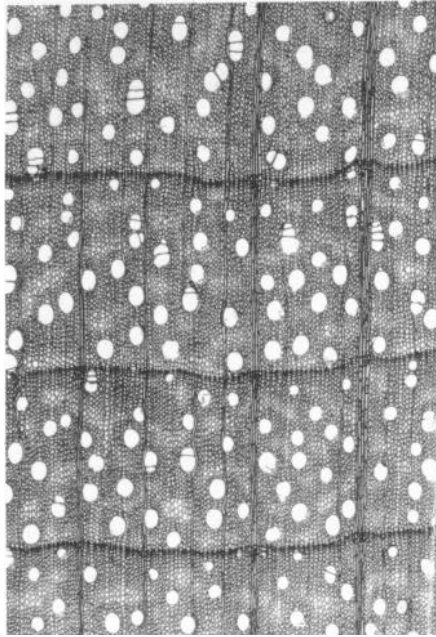

Figure 7.— Sugar maple, 33× (wood substance about 42 pct. and air space 58 pct.).

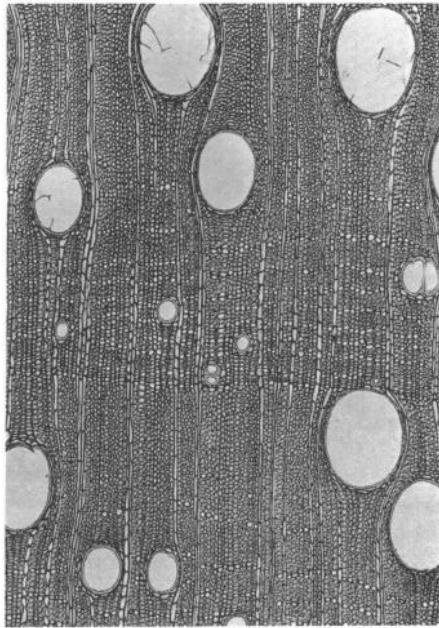

Figure 8.— Hickory (true) 33× (wood substance about 48 pct. and air space 52 pct.).

than one-fifth of the area is wood substance and the remainder is air space. A transverse section of aspen (fig. 5) indicates this species contains slightly more than one-quarter wood substance and about three-quarters air space. Throughout the cell structure of this wood, numerous vessels are about evenly dispersed (diffuse-porous).

A transverse section of Douglas-fir (fig. 6) shows this species has about one-third wood substance and two-thirds air space. In Douglas-fir latewood the cell walls are thick and the cell diameters relatively small. In the earlywood the cell openings increase and the cell wall thickness decreases.

Another diffuse-porous wood, sugar maple (fig. 7), has about 42 percent wood substance and 58 percent air space.

One of the most dense native species, hickory, is shown in cross section in figure 8. Hickory surpasses practically all other commercial native species in shock resistance and in some other strength properties. Hickory averages about 50-50 air space and wood substance. Since hickory is about 50 percent wood substance, compared to 20 percent for western redcedar, it is reasonable to assume that "splicing" of hickory requires different bonding agents and procedures than "splicing" of western redcedar.

SHRINKING AND SWELLING

In ordinary use, wood shrinks as it gives off moisture and swells as it absorbs moisture. These dimensional changes generally put stresses on joints in glued products, the higher the stresses, the stronger the glue joints must be to avoid bond failure. Figure 9 shows the approximate change in volumetric shrinkage of wood of various specific gravities with changes in moisture content from bone-dry to the fiber saturation point (the point at which further increase in moisture content causes no swelling or change in volume). These data also

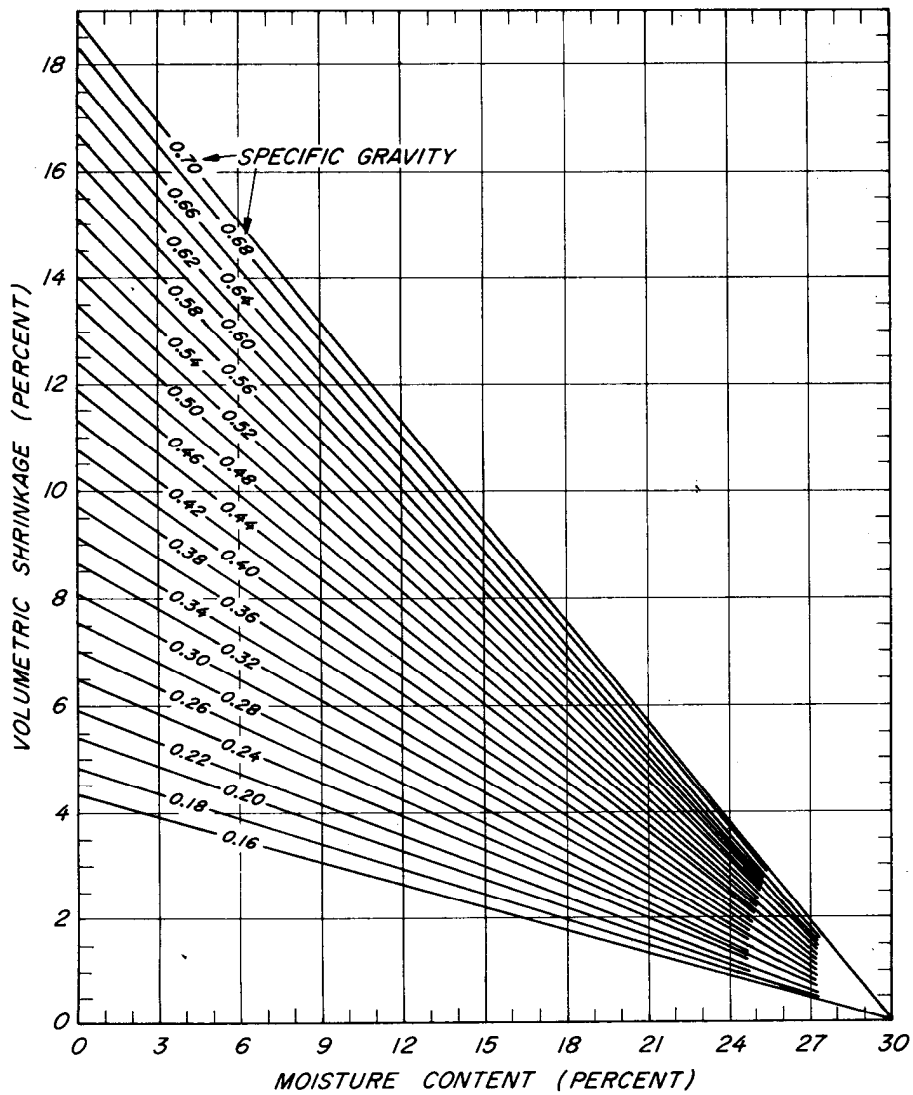

Figure 9.—Relation between volumetric shrinkage and specific gravity as the moisture content changes.

indicate the need for higher quality glue and stronger glue joints as the density and shrinkage potential of the wood increase.

Figure 10 illustrates how joints made with three types of glue performed on three species of various densities and shrinking and swelling characteristics during three soak-dry cycles. With each adhesive type, the joints in the species of the highest

density and greatest shrinkage (white oak) developed the largest amount of failure in the glue joints; the joints in the lightest species (Sitka spruce) developed the least glue failure. Obviously, the glue and gluing condition that have given excellent bonds on a light species such as Sitka spruce may not be adequate for a dense wood such as white oak.

SELECTED REFERENCES

Northcott, P. L.

1964. Specific gravity influences wood bond durability. *Adhes. Age* 7(10):34-36.

Perry, D. A., and Choong, E. T.

1968. Effect of surface aging and extraction treatment on gluability of southern pine veneer. *La. State Univ. Wood Util. Note* No. 13, 3 p. *La. Sch. Forest.*

Rice, J. T.

1965. Effect of urea-formaldehyde resin viscosity on plywood wood bond durability. *For. Prod. J.* 15(3):107-112.

Stamm, A. J.

1946. Passage of liquids, vapors, and dissolved materials through softwood. U.S. Dept. Agric., Tech. Bull. No. 929. 80 p.

Truax, T. R., Browne, F. L., and Brouse, D.

1929. Significance of mechanical wood joints for the selection of woodworking glues. *Ind. and Eng. Chem.* 21:74-79.

U.S. Forest Products Laboratory, Forest Service

1974. Wood handbook: Wood as an engineering material. U.S. Dept. Agric., Agric. Handb. 72, rev. 432 p.

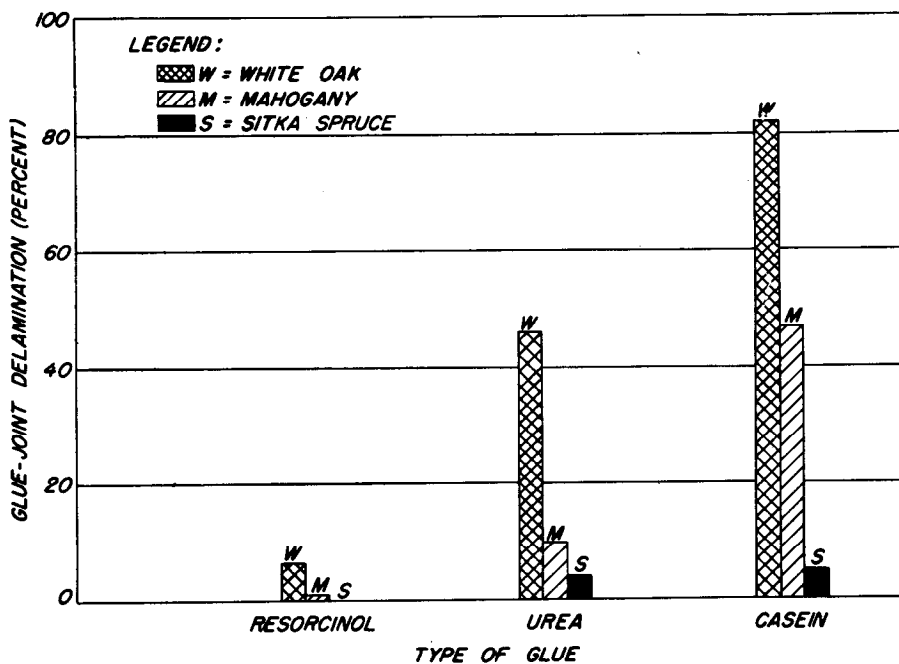

Figure 10.— Effect of species on glue-joint delamination in gusset-type assembly joints made of white oak, mahogany, and Sitka spruce framing members and Douglas-fir plywood gussets. The specimens were exposed to three soak-dry cycles (ASTM D 1101-59).

ADHESIVES FOR WOOD

Until nearly the middle of the 20th century, glues based on naturally occurring materials were the principal adhesive bonding agents for wood. The basic ingredients for these generally were byproducts of meat processing (for animal and blood glues), or casein, soybean, and starch.

In the early 1930's, synthetic resin adhesives began to appear on the woodworking scene; because of their versatility and other advantages, they found widespread use in the woodworking industry. Some synthetic resin adhesives, when properly used, will produce joints that remain as strong as the wood even in unprotected exposure to the weather. More of them, and most of the "natural" glues, will produce adequate joints for normally dry interior use.

SYNTHETIC ADHESIVES

The more important adhesives for wood are currently produced by chemical synthesis. The general synthesis of resin glues is discussed in numerous textbooks and other publications and will not be repeated here. Production details may vary among manufacturers and are usually not disclosed except in the patent literature.

A hardener or setting agent is usually required to convert synthetic adhesives from liquid to solid. These agents may be furnished separately for addition to the resin before use, or they may be present (particularly with spray-dried powdered resins) in the resin as supplied. Hardeners sometimes fall in the class of catalysts which increase the rate of curing but are not consumed in the reaction.

Use of fillers with synthetic adhesives is rather common. Fillers are generally inert materials that are added to the resins in

small proportions to improve working properties such as viscosity of the adhesive. Walnut shell flour is the most commonly used filler.

Extenders are low-cost materials (wheat flour, for example) added to resins to reduce the cost of the adhesive. Highly extended urea resins are often used for plywood where low moisture resistance or durability is adequate. When phenol resins are used for bonding interior-type plywood, they are commonly extended with materials such as lignin, dried blood, and specially treated Douglas-fir bark.

The chief advantage of some synthetic resin adhesives is their excellent durability, making glued wood products serviceable under more severe exposures than was possible with the nonresin glues. When properly used, most synthetic adhesives are capable of producing side grain-to-side grain joints as strong in shear as the wood itself with most species native to continental United States. Some are capable of maintaining their strength under practically any condition of service where wood is a suitable material. Others have only moderate resistance to heat or moisture or both and are not suitable for critical or severe use conditions. Between these two extremes in durability, a wide range of synthetic resin adhesives is available.

Development of synthetic resin adhesives has facilitated manufacture of many important glued wood products. Among these are laminated bridge timbers, ship keels and frames, and other laminated members for use under severe service; plywood for boats, signs, railroad cars, and other exterior uses; and components for houses and similar structures.

Most of the synthetic woodworking adhesives currently in use set or cure by chemical reaction. The rate of curing, like



M 131 639

Figure 11.— Test fence for evaluation of glue-bond durability in plywood. The Forest Service maintains four such test areas to determine durability of adhesives under different climatic conditions. One test area is near Madison, Wis.; one south of Olympia, Wash.; one at San Joaquin Experimental Range, Calif.; and the fourth at the Harrison National Forest, La. Various types of glued wood products are exposed at each site.

that of all chemical reactions, depends on temperature, in this case the temperature of the glue. Raising the glue-line temperature speeds the rate of curing as well as the rate of strength development of the joint. This property is used to advantage in high-frequency heating, steam-heated platens, and other means of heating in high-speed production processes.

One of the most important differences among the various types of resin adhesives is their durability, or resistance to deterioration under various service conditions. For some types—the phenols, resorcinols, ureas, melamines, and polyvinyls—considerable data and service records indicate their durability. With other types, laboratory data and experience are much more limited and hardly justify long-term performance forecasts.

The following generalizations are based on numerous exposures of glued specimens, both laboratory-controlled and exposed to the weather (fig. 11), and on service records from various parts of the country (fig. 12).

While the synthetic resins can be considered in a variety of groupings, they are discussed here under general headings. These include phenolics, ureas, melamines, polyvinyl resin emulsions, hot melts, epoxies, contacts, mastics, and various combinations of specific adhesives.

Phenolic Resins

Phenolic resins are formed by reacting formaldehyde with phenol in what is called a condensation reaction. These may be considered in four categories: High-tempera-

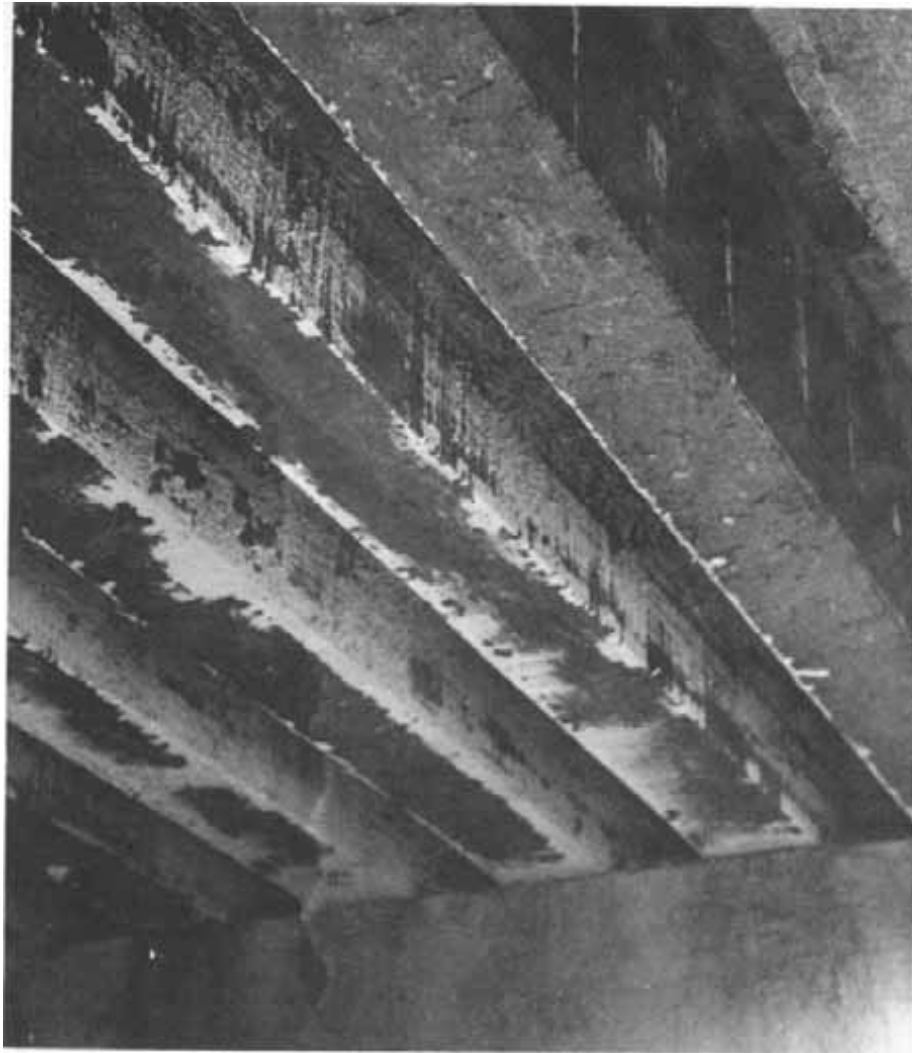

M 124 522

Figure 12.— Partial view of 11 creosoted laminated southern pine bridge stringers installed on the Texas & Pacific Railroad near Woodlawn, Tex., 1944. No joint separation or other sign of deterioration is apparent. The light gray material shown on the stringers is sandy silt that has seeped down from the ballast above.

ture-setting phenolics, intermediate-temperature-setting phenolics, resorcinols, and phenol-resorcinols. Because durability

of the phenolics is generally similar, this phase is summarized after the individual types are discussed.

HIGH-TEMPERATURE-SETTING PHENOLICS

Phenol-formaldehyde adhesives were first introduced in film form (about 1920). In production of this type of adhesive, the resin is deposited on a tissuelike paper and the solvent removed by drying. The film form of phenolic was particularly convenient for making plywood from thin veneers since no increase in moisture content was involved.

As softwood plywood approached mass production status, phenolic resins became available in liquid form, making exterior plywood a reality. This development permitted application of adhesive by roll spreaders and variation in spreads as veneer quality required.

Phenolic resins are also available as spray-dried powders to be mixed in water or water-alcohol solutions before use. These phenolic resins (both liquid and film form) require heat for curing to complete polymerization; thus they prompted development of hot presses.

Neat phenolic resins as used in the earliest production of exterior plywood had a tendency to "bleed-through" or penetrate the wood excessively, particularly in loose-cut veneer. Incorporation of fillers such as walnut shell flour or powdered oat hull residue produced a more workable adhesive by reducing penetration. Small amounts of wheat flour or heat-treated dry blood also have been used with phenolic resins, reportedly decreasing the cure time. Recently, it has been reported that neat resins, with higher solid contents applied with thinner spread than the filled resins, are performing very satisfactorily and also permit higher moisture content in veneers.

The phenolic resins used for making plywood are generally alkaline and require high temperatures for proper curing. Acid phenolic glues were also developed to set at moderate-to-room temperatures, but acid types have not found volume use. The excellent durability characteristics of the alkaline phenolics prompted their wide-

spread use in structural plywood and other applications.

The alkaline phenol resin adhesives normally cure at 265° to 310° F. As a result, their use is restricted almost entirely to gluing the more durable types of plywood and related thin products that can be heated to these temperatures in a practical time period. Phenol resins have been formulated to cure at temperatures as low as 240° F. for hot pressing, but such formulations are not in common use in the United States.

The major use of liquid phenol resin adhesives is for bonding exterior softwood plywood, including boat hull plywood and products for other marine uses. Their use in hardwood plywood manufacture is more limited. Liquid phenol resins formulated specially for softwood plywood production are generally quite reactive; as a result they have relatively short storage lives. Where longer storage is required, the powdered phenol resins are often used. They are prepared for use by dissolving in water or in water and alcohol and in some cases may require addition of separate hardeners.

Phenol resins are commonly used with some walnut shell flour or other filler, but without extenders where highest joint durability is required. In recent years, considerable amounts of interior-type softwood plywood also have been made with phenol resin to which were added fairly high proportions of extenders and fillers such as ground bark, wood or walnut shell flour, dry soluble blood, or certain other agricultural residues. These phenol adhesives replaced conventional protein glues used for interior plywood for several decades.

Phenol resins can be formulated, within limits, to suit the manufacturing operations of the glued products. The curing cycle or length of the pressure period in the hot press can be controlled at least partially by the proper amount and type of catalyst and by the way in which the resin is made. Assembly periods depend somewhat on reactivity of the adhesive, but they

can generally be controlled within practical limits. With some formulations for high-speed, flat plywood production, assembly periods as long as 15 minutes at 70° to 80° F. are permissible. For other formulations, an all-open assembly period of several hours or days can be allowed, as may be necessary in bag molding operations where a long layup period is unavoidable. Adhesives for bag molding (see Pressing and Clamping) must permit assembly of neatly tack-free, glue-coated veneers and yet later flow adequately when heat and pressure are applied in the final curing operation.

The dry film form of phenol resin adhesive is well adapted to gluing thin, and particularly crotch, veneers because there is no problem involved in controlling spread. Moreover, the danger of bleed-through is almost nil. Since the film weighs about 12-1/2 pounds per 1,000 square feet and approximately one-third of this weight is paper, a relatively light spread of resin is obtained when a single sheet is used per glue-line. If film glues are to be used successfully, the veneer must be well cut, smooth, and uniform in thickness. Since the film glue contains little or no water, all moisture needed for softening the resin and providing the necessary flow during pressing must come from the veneers. For this reason, the control of moisture content in the veneers is even more critical with a phenol resin film adhesive than with conventional glues applied in liquid form.

Film adhesives normally do not give good results on veneer at moisture contents of less than 6 percent. The most satisfactory moisture content of veneer for gluing with phenol resin films varies somewhat with the species and veneer thickness; in general, good results are obtained in the range of 8 to 12 percent. Too high a moisture content may cause blisters, excessive bleed-through, and starved joints; one that is too low usually results in dried joints of low strength. For furniture and similar interior uses, optimum moisture

content with this type of glue is about 8 percent.

INTERMEDIATE-TEMPERATURE-SETTING PHENOLICS

The intermediate-temperature-setting types of phenol resin adhesives were developed as durable glues that could be cured at 210° F. or less, such as in heated chambers or electrically heated jigs. Special formulations of phenol resins were offered for this purpose, being more reactive at the lower curing temperatures because of rather highly acid catalysts. Thus, this type of adhesive has often been referred to as acid-catalyzed phenol resin. Some formulations are suitable for gluing plywood at temperatures as low as 80° F. if the pressure periods are overnight or longer and if several days of additional conditioning are allowed before subjecting the plywood to severe service.

The acid-catalyzed phenol resin adhesives have been used to a limited extent for gluing sandwich panels, prefabricated house panels, and truck panels. They are normally supplied as liquid resins with the acid catalyst furnished separately for addition at the time of use. Acid-catalyzed phenol resins do not glue as well on wood at 6 percent moisture content as at 10 to 12 percent.

Since the introduction of the resorcinol and phenol-resorcinol resin adhesives, the acid-catalyzed phenol resin adhesives have not been extensively used, although they are generally somewhat cheaper and are lighter colored than the phenol-resorcinol and resorcinol resins. The acid-catalyzed phenol resins are not considered as durable as the resorcinol resin types for long-time severe service and elevated-temperature exposures.

RESORCINOLS

Adhesives based on resorcinol-formaldehyde resins were first introduced in 1943.

Almost immediately they found wide application in gluing laminated members such as keels, stems, and frames for naval vessels, and for assembly gluing and laminating in wood aircraft where the combination of high durability and moderate-temperature curing was extremely important.

The resorcinol resins bear many resemblances to phenol resins. A principal difference is the greater reactivity of the resorcinol resins, which permits curing at lower temperatures. Resorcinols are supplied in two components as a dark reddish liquid resin with a powdered, or at times with a liquid, hardener. These glues cure at 70° F. or higher, but usually are not recommended for use below 70° F. with softwoods and generally require somewhat higher cure temperatures with dense hardwoods. Straight resorcinol resin adhesives have storage lives of at least a year at 70° F. Their working lives are usually from 2 to 4 hours at 70° F.

Assembly periods are not too critical on softwoods as long as the glue is still fluid when gluing pressure is applied. On dense hardwoods, such as oak, the assembly period must be adjusted (usually extended) to give a rather viscous glue at the time the assembly is pressed. One- to 2-hour assembly periods have been used with good results when gluing oak at 70° to 80° F., but the actual assembly time for a particular formulation depends on the age and viscosity of the glue at the time of spreading as well as the temperature, absorptiveness of the wood, and other factors. Resorcinol adhesives are ideal for laminating large timbers that require considerable time to assemble and bring under pressure. Very short assembly periods with dense woods can result in "starved" joints and should be avoided.

Resorcinol resin glues will cure adequately on thin plywood and other light constructions of medium- to low-density species at about 70° F. For such high-density hardwoods as white oak, used for laminating ship timbers and similar items, curing for several hours at about 150° F.

glueline temperature has been necessary. If facilities for raising the temperature of the gluelines to such levels are not available, adequate bonds can be obtained by extending curing periods.

These glues, as well as phenol-resorcinol modifications, have earned an outstanding reputation for performance under severe service conditions. Bridge timbers laminated with them are still in excellent condition after more than a quarter century of service. Laminated oak timbers for minesweepers have gained a similar reputation. Resorcinol resin adhesives are not affected by the commonly used preservative treatments, which permits treating the glued timbers for long-term service. They also bond treated wood, making it feasible to treat the lumber and then glue the assemblies to the desired size and shape. This is particularly advantageous where large, curved members that cannot be treated in cylinders are involved. Special formulations have also been developed for gluing fire-retardant-treated wood.

PHENOL-RESORCINOLS

Phenol-resorcinol resins are modifications of straight resorcinol resin adhesives produced by polymerizing the two resins (phenol-formaldehyde and resorcinol-formaldehyde). The principal advantage of the copolymer resins over straight resorcinol resin is their significantly lower cost, because the price of phenol is much lower than that of resorcinol. This cost advantage apparently is achieved without any significant losses in joint performance. For wood gluing, the volume of phenol-resorcinol used now far exceeds that of straight resorcinol. Proportions of the two resin components in the copolymer are not generally revealed by the manufacturers. Like their components, the copolymer resins are dark reddish liquids and are prepared for use by adding powdered hardeners. The hardeners generally consist of paraformaldehyde and walnut shell flour, mixed in equal parts by weight.

Phenol-resorcinol resins generally have shorter storage lives than straight resorcinol resins, usually somewhat under 1 year at 70° F. Many manufacturers formulate phenol-resorcinols to fit prevailing temperature conditions-fast-setting resins for cool weather, somewhat slower setting ones for warmer weather, and still slower ones for hot weather. This is particularly helpful for the laminating industry, where the curing time could become prohibitively long with a slow-setting resin during cooler weather and the permissible assembly time could be difficult to meet with fast-setting resins during hot weather.

Research has shown that, as the curing temperature is increased, the required curing period decreases logarithmically. Figure 13 shows the relation between curing temperature and curing time for five different resorcinol and phenol-resorcinol adhesives. With glues A, C, and E, about the same joint quality could be obtained in laminated white oak when the glue line was heated for about 6 minutes

or more at 150° F. as when it was heated for about 2,500 hours at 80° F.

Originally, resorcinol and phenol-resorcinol adhesives were rather costly, which limited their use almost exclusively to the most severe service conditions. Within recent years, however, the price has come to about a third of what was common several decades ago.

DURABILITY OF PHENOLIC RESINS

The durability of moderately alkaline phenol resin, resorcinol resin, and phenol-resorcinol resin adhesives is essentially similar. When these glues are properly used, they are capable of producing joints that are about as durable as the wood itself under various severe service conditions studied. Properly made joints will withstand, without significant delamination or loss in strength, prolonged exposures to cold and hot water, to alternate soaking and drying, to temperatures up to those that seriously damage the wood, to high

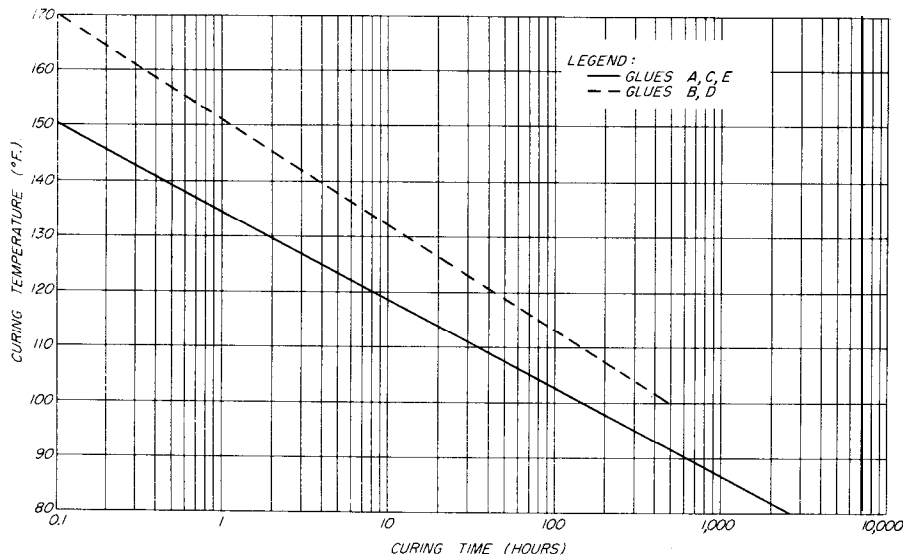

M 112 243

Figure 13.— Minimum curing times required at different temperatures for five resorcinol and phenol-resorcinol glues on white oak. A and B are phenol-resorcinols; C, D, and E are resorcinols.

Urea Resins

relative humidities where many untreated species decay, and to outdoor weathering without protection from the elements.

The joints between lumber laminations or plies of plywood made with these adhesives will not separate when exposed to fire. The glues are not weakened by fungi, bacteria, or other micro-organisms and are avoided by termites. These adhesives, however, do not offer any significant protection to the adjacent wood. Consequently, wood products glued with these adhesives should be considered no more decay- or insect-resistant than solid woods of the same species.

Glued wood is subject to shrinkage stresses and, even if the glue joints are durable, splitting and checking might occur adjacent to or away from the glue joints. For severe service, therefore, it is important to employ treatments that protect against wood-degrading organisms and also impart water repellency, thus reducing shrinking and swelling stresses in the glued member.

Completely cured phenolic-type glue joints (made with neutral or moderately alkaline resins) are highly resistant to the action of solvents, oils, acids, alkalies, wood preservatives, and fire-retardant chemicals. Thus, in general, well-made joints bonded with phenol, phenol-resorcinol, and resorcinol resin glues are difficult to destroy without destroying the wood itself. However, as with other types of glues, joints poorly made with these durable adhesives may fail in service.

Acid-catalyzed phenol resins have shown good durability in such applications as bonding honeycomb paper core to plywood faces of sandwich panels. With dense species, such as white oak, much lower shear strength was obtained with acid-catalyzed phenol glue than with phenol-resorcinols. Under exposure to elevated temperatures such as 158° F., the joint quality was reduced more than for the conventional alkaline phenol resin adhesives.

Urea-formaldehyde resin adhesives came on the market in the middle to late 1930's. By using different types and amounts of catalyst, they can be formulated either for hot-pressing or for room-temperature curing. They are compatible with various low-cost extenders or fillers, thus permitting variation in both quality and cost. Even the hot-press formulations set at appreciably lower temperatures than the alkaline phenolic adhesives. Being light in color or slightly tan, urea adhesives form a rather inconspicuous glueline. But exposure to moist conditions, and particularly to warm, humid surroundings, leads to deterioration and eventual failure of urea resin adhesive bonds. Durability of urea-resin adhesives is summarized at the end of this section.

Major uses for urea resins are in hardwood plywood, particleboard, and furniture manufacture. They are also available in the retail trade for home workshop use.

Urea resins are generally marketed in liquid form (as water suspensions) where large-scale use is involved and shipping distances are not excessive. They are available with solids contents from about 40 to 70 percent. They are also marketed as dry powders, with or without catalyst incorporated. The powdered ureas are prepared for use by mixing with water or with water and catalyst if the catalyst is supplied separately. In general, powdered urea resin adhesives with separate catalysts have longer storage lives than the liquid urea resins or the powdered types with catalysts incorporated.

Urea resins are generally more versatile than some other resin adhesives; the same resin, as received from the manufacturer, can be used for either hot-pressing or room-temperature cure by addition of the proper catalyst. Some manufacturers, however, supply different resins for hot-pressing and for room-temperature curing. Special formulations have been developed for such

uses as high-frequency curing and for tapeless splicing of veneers.

Urea resin adhesives can be extended with cereal flour to reduce cost where the joint strength and durability attainable with unextended glue are not required, such as in mild exposures with low-shrinkage woods. Wheat and rye flours are most commonly used for extenders, and extensions up to 100 parts by weight of flour to 100 parts resin solids (100 pct. extension) are used with room-temperature-curing formulations for bonding hardwood plywood. Extensions up to 150 parts flour per 100 parts resin solids (150 pct extension) are sometimes used in hot-pressing hardwood plywood.

Various grades of wheat flour affect the working properties of the adhesive differently, particularly consistency and tendency to foam, and may also influence the effect of the catalyst used. Flour extension generally makes the adhesive more viscous; the degree of change depends on the amount and type of flour and also on the protein content of the flour (formaldehyde reacts readily with protein).

A small amount of sodium bisulfite (1 to 2 pct. by weight) is sometimes added to the flour during mixing with the resin to help overcome differences in flours and to reduce the amount of additional water that might otherwise be needed to make a spreadable mixture. The addition of sodium bisulfite may affect the catalyst system of some adhesives, and the user should obtain the recommendations of the glue supplier for the type and amount of extension suitable for a particular product. Extended glues often require somewhat heavier spreads and shorter assembly periods than the corresponding unextended glues.

Urea resin adhesives for edge gluing, assembly, veneer splicing, and laminating of furniture parts are not normally extended with cereal flours, but they do contain some walnut shell flour as filler to improve working properties.

Urea resins are normally not recommended for use on wood below 6 percent in moisture content. This limitation appears to be related to the porosity of the species and to the rate at which moisture is absorbed from the adhesive by the wood.

HOT-PRESS UREA RESINS

Hot-press urea resin adhesives are normally cured at 240° to 260° F. Assembly periods vary considerably for the different formulations. Many typical adhesives are formulated for assembly periods of 10 to 30 minutes, but special formulations may permit assembly periods of 24 hours or more. Because of their relatively high reactivity, some urea resin adhesives precure on hot cauls or platens before full gluing pressure is applied. This can be avoided by use of cooled cauls and proper sequence in the spreading and press-loading operations.

Urea resins cure much faster than phenol resins at the same temperature. When this advantage of ureas is added to their lower costs and lack of color, they are attractive for gluing furniture and architectural plywood for interior use where the greater durability of the phenol resin glues usually is not required. Typical recommendations for curing hot-press urea resins are 2 to 5 minutes for panels with a total thickness of 3/16 inch or less and 8 to 10 minutes for 1-inch panels with about 1/2-inch cores when the platen temperature is 260° F. and one panel is glued per press opening.

For certain products and service conditions, the durability of hot-press urea resins can be improved by adding more durable resins or special resin-forming ingredients. These additives are generally referred to as fortifiers and the resultant glues as fortified urea resin glues. The most widely used fortifiers are the melamine resins, but crystal resorcinol has also been employed. The amount of fortifier varies considerably. Under more severe conditions, including outdoor weathering of

plywood, durability has generally improved as the amount of fortifier is increased. Because of the special interest in melamine-urea resin adhesives, these are described separately. No entirely adequate room-temperature-setting fortified urea resin glues have yet been introduced for industrial use.

ROOM-TEMPERATURE-SETTING UREA RESINS

Urea resins classified as room-temperature-setting are formulated to cure at temperatures of 70° F. or higher. They were the first synthetic adhesives developed for practical use at normal room temperatures. They were extensively used in assembly gluing of aircraft parts, truck body parts, and similar items before the introduction of the more durable room-temperature-setting resorcinol resin glues.

In addition to their use in cold-pressing plywood (with hydraulic presses, I-beams, and retaining clamps to maintain the pressure after removal from the press), room-temperature-setting ureas are now used for edge gluing on clamp carriers, in various assembly operations, and for laminating furniture parts. Their availability in small retail packages as dry powders that require only the addition of water makes them very convenient for small job and home workshop uses.

The working life of a glue of this type is usually from 3 to 5 hours at 70° F. and less at higher temperatures. Special slow-acting catalysts increase the working life of room-temperature-setting urea resins during hot weather and make them more practical for use during summer months in plywood and other commercial applications.

Assembly periods with these adhesives are fairly short, usually with maximum closed assembly of 30 minutes at 70° F. for critical applications. The maximum permissible assembly period depends on

temperature and somewhat on the moisture content of the wood, amount of extension, and the amount of glue spread.

The minimum pressure period depends on the type of glued product and upon the temperature of the wood and the room, for these temperatures control the speed of the curing reaction. Because of slow heat transfer through the wood, room-temperature-setting urea resin glues generally cure inadequately if the glue is spread on cold wood and then clamped for only a short time at 70° to 80° F. At 70° F. a pressing period of at least 4 hours is generally required on thin, flat members, such as plywood, and at least 6 to 8 hours is required on heavy or curved members. Longer pressing periods are generally required for heavy species than for lighter ones. In no case should pressure be released until the squeezeout is hard.

Room-temperature-setting urea resin formulations are often used in special heat-curing operations with heated jigs and high-frequency curing to get faster setting than is possible with conventional hot-press formulations. But if assembly periods are excessive, the adhesive may pre-cure before gluing pressure is applied. A room-temperature-setting glue must be fluid at the time pressure is applied to adequately transfer glue to the unspread surface.

These glues will harden at temperatures below 70° F. but at a very slow rate, and joints with erratic strength and durability may result. Curing below 70° F. is therefore generally not recommended.

In special applications where rapid strength development at room temperature is of primary importance, the normal room-temperature-setting urea resin formulation without catalyst may be applied to one wood surface and a strong acidic catalyst applied to the mating surface. Sometimes the liquid catalyst is applied in advance and air dried. The joint is then assembled and pressure quickly applied. The separately applied catalyst is assumed to penetrate into the glue and to cause rapid setting. Such strong catalysts cannot

be incorporated in the glue before spreading because they shorten pot life.

This technique is referred to as the "separately applied catalyst process." When properly conducted, it results in rapid development of joint strength, thus permitting a shorter pressing period than with adhesives having catalyst mixed with the resin. The process has not been widely accepted, however, because it is difficult to obtain uniform mixture of catalyst and resin. Uneven penetration results in erratic joint quality; moreover, the highly acid glueline does not seem to be as durable as gluelines made with adhesive of the same type without separately applied catalyst.

DURABILITY OF UREA RESINS

In general, well-made urea resin glue joints develop high original dry strength and wood failures with almost all U.S. commercial species, good resistance to continuous soaking in cold water, and fair resistance to continuously high relative humidity and alternatively high and low relative humidity. Nevertheless, a combination of high relative humidity and high temperature deteriorates urea resin glue bonds in a relatively short time.

Resistance to cyclic soaking and drying exposures is reasonably good if the test pieces are plywood or thin members, but only moderate to low resistance is obtained if the pieces are heavy laminations of dense wood. This applies to short-term exposures. Over the long term, urea resin glue joints deteriorate under the exposures mentioned, and the rate of deterioration usually increases with the density of the species. Urea resin glue bonds are generally destroyed by boil tests (generally 4 hr. boiling, 20 hr. drying at $145^{\circ} \pm 5^{\circ}$ F., 4 hr. boiling, cooling, and testing wet, Prod. Std. PS 1-66) as used for glue-joint evaluation of exterior-type plywood.

The fortified urea resins are more durable under practically all of the exposure conditions named. They are followed, in

order of decreasing durability, by the hot-press urea resins, room-temperature-setting urea resins, and highly extended urea resins. Tests made with hot-press urea resin glue extended with rye flour showed that the wet joint strength falls off slowly as more flour is added. No important decrease in wet joint strengths was apparent until 50 to 100 percent of extender, based upon the weight of dry resin, had been added. Under dry conditions, the dry joint strength decreased still more slowly, and joints containing twice as much rye flour as resin exhibited high strength.

Under conditions conducive to development of mold and other micro-organisms, joints made with extended urea resin glues also lost strength more rapidly than unextended glues. The loss was noticeable with as little as 10 percent flour and particularly rapid for glues having greater extensions. Tests with preservatives showed that the mold resistance of flour-extended urea resins could be increased by adding chlorinated phenols to the glue in amounts equal to 5 percent of the weight of the flour. (Concentrations lower than 5 pct. appeared to offer less protection, but there seemed to be little advantage in increasing the concentration above 5 pct.) These preservatives seem to delay the effect of the micro-organism damage, but they are unable to prevent it over long periods of exposure to high moisture conditions.

Thus, except for highly fortified types, the urea resins as a group are low in durability under conditions involving high temperatures and humidities. At high temperatures and extremely low relative humidity the joints are more durable, but this is mainly of academic interest because such conditions rarely exist where glued wood products are used. Gradual weakening of room-temperature-setting and hot-press urea resin glue joints occurs under dry conditions at 160° F. A much less significant weakening of room-temperature-setting urea resin glue joints has been observed in birch plywood under continuous exposure at 80° F. and 65

percent relative humidity. The rate of strength loss is increased by high humidity at 80° F.

Delamination usually occurs within a few hours in boiling water. Urea resin bonds tend to break down at temperatures that char wood; therefore, when certain urea resin-bonded plywoods are exposed to fire, even for short periods, the plies may delaminate. Plywood panels made with unfortified room-temperature-setting and hot-press urea resin adhesives have shown considerable delamination after 2 to 3 years of outdoor exposure at Madison, Wis. Panels made with fortified urea resins have shown much less delamination in the same length of time. Under exterior exposure and where high temperatures with or without high relative humidities are involved, urea resin glues are markedly less durable than phenol, resorcinol, and melamine resin glues. (This does not imply that melamine glues have the same durability characteristics as phenol and resorcinol resins.)

Admittedly, urea resin glue joints (in unfinished specimens-no lacquer, varnish, or paint) have shown much larger decreases in strength than phenol, resorcinol, phenol-resorcinol, and melamine resin glue joints after several years' exposure to less severe laboratory-controlled conditions. Nevertheless, high-quality urea resin glue joints do appear to be sufficiently durable for nonstructural interior applications within the human comfort range of temperature and humidity conditions. On the other hand, particularly with high shrinkage, dense species, the more durable resin adhesives would assure longer trouble-free service life.

Melamine Resins

Melamine resin adhesives are normally of the hot-press type, curing at 240° to 260° F., similar to the hot-press urea-resin glues. Special formulations have sometimes been offered for curing at temperatures as low as 140° F., but

they have not been widely used. Some of the high-temperature-setting melamines will cure adequately at temperatures from 140° to 180° F. if the curing period is extended to 10 hours or more. Laminated Douglas-fir beams bonded with these glues and cured overnight at 140° F. have shown excellent performance in outside exposure for up to 20 years.

Most of the melamine resin glues are marketed as powders that are prepared for use by mixing with water and sometimes with a separate hardener. Those using hardeners or catalysts will set much more rapidly or at lower temperatures than those cured without hardeners. There have been indications, however, that the catalyzed melamines do not have the same resistance to weather that the uncatalyzed ones have.

Pure melamine resin adhesives are almost white, but the addition of filler usually gives them a light tan color similar to the urea resins. The filler is usually walnut shell flour, but occasionally wood flour is used.

Melamine resins have been used to a limited extent for gluing hardwood plywood where the darkness of phenol resins is objectionable and durability approaching that of phenol resins is required. Melamine resins are considerably more expensive than phenol or urea resins.

Uncatalyzed melamine resin glues also have been investigated for gluing heavy laminated ship timbers at curing temperatures of 140° to 190° F. On Douglas-fir they showed promising results, but on oak the glue bond deteriorated when the specimens were soaked in salt water (simulating sea water) for 15 years. Current commercial applications of melamine resin glues in structural wood laminating include bonding interior finger joints, laminated decking, and laminated beams with 60:40 melamine-urea combinations and high-frequency curing. The melamine resins have been used successfully in high-frequency edge gluing where a durable, colorless glueline is required.

As a group, melamine resin adhesives generally have a pot life of at least 8 hours at 70° F. and they tolerate rather long open and closed assembly periods.

Slow-curing, uncatalyzed melamine resin glues have shown good durability characteristics on laminated Douglas-fir beams exposed for several decades to the weather. Similar glues used for laminating white oak failed almost completely after 15 years of soaking in salt water. Rapid-setting, catalyzed melamine resin glues, in limited tests, have not shown the same durability as indicated with uncatalyzed melamines on softwood species.

Melamine-Urea Resins

Melamine-urea resins are a special group of hot-press adhesives produced by either dry blending urea and melamine resins or by blending the two separate resins in liquid solution and then spray-drying the mixture. In either case, the resins are supplied by the manufacturer as powders, to be prepared by adding water and catalyst. Reportedly, the adhesive produced by spray-drying a mixture of the two resins produces somewhat more durable bonds than the one produced by blending the two powdered resins. At present, the most common combinations are said to contain 40 to 50 percent by weight of melamine resin and 50 to 60 percent of urea resin on a solid basis.

In finger-jointing lumber for structural laminated timbers, a 60:40 melamine-to-urea ratio is used. Such joints, when properly produced, are considered adequate for normally dry interior service but are not recommended where long-term exterior use is involved. The melamine-urea combinations are used in much the same way as the hot-press ureas and melamine glues, curing at 240° to 260° F. in manufacture of plywood. In finger-jointing operations, they are generally cured by high-frequency heating. The melamine-urea resin glues offer advantages for hardwood plywood in that they are colorless, more

durable than urea resins, cheaper than straight melamine or resorcinol resins, and capable of curing at lower hot-press temperatures than conventional phenol resin glues.

Polyvinyl Resin Emulsions

Polyvinyl resin emulsions are thermoplastic, softening when the temperature is raised to a particular level and hardening again when cooled. They are prepared by emulsion polymerization of vinyl acetate and other monomers in water under controlled conditions. Since individual types of monomers are not identified by the manufacturer, this group is simply referred to as polyvinyl resins or PVA's. In the emulsified form, the polyvinyl resins are dispersed in water and have a consistency and nonvolatile content generally comparable to the thermosetting resin glues. They are marketed as milky-white fluids to be used at room temperature in the form supplied by the manufacturer, normally without addition of separate hardeners.

The adhesive sets when the water of the emulsion partially diffuses into the wood and the emulsified resin coagulates. There is no apparent chemical curing reaction, as with the thermosetting resins.

Setting is comparatively rapid at room temperature, and for some constructions it may be possible to release the clamping pressure in half an hour or less. Limited tests indicate that some of these glues set in most wood joints at 75° F. at a rate comparable to that of hot animal glue.

The polyvinyl resins have indefinitely long storage (in tight containers) and working lives (at normal room temperatures) and can be used as long as the resin remains dispersed. Coagulation in storage by evaporation or freezing must be avoided, although special emulsions have been offered that are said to withstand repeated freezing and thawing. The set resins are light in color, often transparent, and result in gluelines that are barely visible.

A considerable amount of variation has been observed in the performance of the different glues of this type. Some of the poorer ones gave considerably lower joint strengths and developed little or no wood failure compared to other types of resin and nonresin glues. On the other hand, joints produced with some of the newer polyvinyl resins gave unusually high shear strengths although generally not high wood failures, particularly with denser species. Such results might be expected of rather elastic-type adhesives, because the load probably will be distributed more uniformly over the entire joint area under test than with brittle glues. The polyvinyl resin adhesives have little dulling effect on the sharp edges of cutting tools, but a tendency to foul sandpaper has been reported.

Some PVA's soften and lose a portion of their strength as the temperature increases above normal room temperature, and the strength of many of them is appreciably reduced at about 160° F. They are also generally weakened more by higher relative humidity conditions than are the thermosetting resin glues.

Probably the most serious limitation in the use of these adhesives in woodworking is the lack of resistance to continuously applied loads. Such "cold flow" is the tendency for a glue to yield to, rather than resist, the stresses exerted on the joint at normal room temperature. This limitation has been most serious when polyvinyl resins have been used for edge-gluing lumber for solid stock, particularly high-density hardwoods, which will not be subsequently veneered. When such a stock is exposed to low humidities, moisture content changes most rapidly through the end grain, with resultant shrinkage stresses across the ends of the panels. When these stresses are of appreciable magnitude and duration, the glue often fails, resulting in open joints.

This cold-flow limitation has encouraged considerable reformulation of polyvinyl resins so several currently available

glues appear to be suitable for edge-gluing applications. However, not all glues show such improvement and no quick and simple screening test is yet available for checking this property. Therefore, the user must exercise caution in selecting such a glue for edge-gluing, particularly of dense species. Screening tests, by cycling panels made with different glues between high and low humidity conditions, might be advisable before using PVA's in full-scale production.

At the British Forest Products Laboratory, joints made with 39 brands of PVA were tested in an atmosphere of 25° C. (77° F.) and 60 percent relative humidity under approximately one-third ultimate load and normal loading rate. Joints with 37 brands failed within 6 months; joints with the other two brands survived and were still intact after 24 months.

Studies have indicated that some polyvinyl resin emulsion glues are promising in assembly joints such as dowel, mortise and tenon, and lock-corner. Their fast setting is of benefit and their elasticity may be an additional advantage where the dimensional changes in the joint are minimal.

In terms of durability, polyvinyl resin emulsion adhesives are considerably less resistant to warm, moist, or humid conditions than the thermosetting resins. The PVA's lack resistance to water and high relative humidities, and a number tend to soften at temperatures as low as 110° F. Even at normal room temperatures, creep or yield of the bond (cold flow) might become a problem if heavy stress is continued on the joint. The low resistance of polyvinyl resin emulsions to water and moisture limit PVA use primarily to non-structural interior applications, as in certain types of furniture joints.

Thermosetting Polyvinyl Emulsions

Thermosetting polyvinyl emulsions, also identified as catalyzed PVA emulsions and cross-linked PVA's, have been avail-

able for a decade. They are modified PVA emulsions and generally have heat and moisture resistance superior to ordinary PVA's, particularly when cured at elevated temperatures.

Room-temperature cure of these adhesives has been insufficient to prevent creep when glued specimens were stressed during exposure at 150° F. and high relative humidity. Therefore, they are not

recommended for structural applications because of creep (fig. 14).

On the other hand, in tests on hot-pressed plywood made with a cross-linked PVA, the joints performed almost as well as those made with phenolic glues.

Further research has shown that these adhesives cannot be classed with resorcinols as being room-temperature-curing and suitable for general structural applications.



M 122 542

Figure 14.— Cross section of laminated oak glued with thermosetting or cross-linked PVA and subjected to vacuum-pressure soaking, steaming, and drying. The bridging in the joint at the center might explain why PVA glues have performed well in cyclic tests on mortise and tenon and dowel joints. Had a brittle glue been used, fractures would probably have occurred either in the bond or adjacent to the glueline. The elastic PVA yielded enough to retain the bond between the joint surfaces.

They are, however, markedly superior to ordinary PVA's in resistance to moist conditions, and there is reason to believe they would perform well in most non-structural interior uses. In common with some other adhesives, they would not be expected to perform as well on dense, high-shrinkage species as on lighter ones.

Hot Melts

Hot-melt adhesives for wood are furnished in solid form, usually as pellets, chunks, granules, or in cord form on reels. They involve a wide variety of thermoplastic mixtures that are converted by heat to spreadable consistency and applied while hot and fluid; they set almost instantaneously as the heat dissipates from the thin glue film to the greater mass of the substrate. Pressure is applied on the joint during formation of the bond. The bond forms very rapidly, depending upon the temperature difference between the glue and the parts being joined. Setting times as brief as a fraction of a second have been reported.

One of the primary uses of hot melts in wood gluing has been for edge banding of panel products. Machines are increasingly common in the furniture industry to apply edge banding to panels with hot melts at about 60 to 100 linear feet per minute. The process is reported to lend itself to application of veneer and thicker edge bands to lumber and particleboard cores. Hot melts are also being used to some extent for bonding decorative overlays or films to particleboard for counter and furniture tops and shelves, and for coating panel products. Methods of application include roll coating, blade coating, and curtain coating.

The composition of hot-melt adhesives varies a great deal and may include polymers, such as ethylene vinyl acetate copolymers, polyamides, polyolefins, and polyesters, as well as other resins or copolymers. These are generally modified with

plasticizers and other ingredients to improve working properties.

Hot melts have melting points covering a rather wide range. Transition points from solid to a soft mass or liquid have been reported from as low as 150° F. to as high as 390° F., although working temperatures in the range of 375° to 410° F. are supposed to be more common.

Some hot melts are reported to be water resistant and provide somewhat elastic gluelines; however, their resistance to heat is generally poor. For best results, good control is required of wood and glue temperatures as well as the rate of application.

Epoxy Resins

Epoxy resin adhesives became available in the 1940's and found a major use for metal bonding in the aircraft industry. However, epoxies do adhere to a variety of substrates and in recent years have been employed as bonding agents in numerous special applications. They are probably the most versatile adhesives currently available in that they adhere to more different substrates than other synthetic or naturally occurring bonding agents. They have not, however, found extensive use for bonding wood.

Epoxy resin refers in a broad sense to a wide variety of polymers characterized in their simplest form by an oxygen atom linked to each of two adjacent carbon atoms on a chain, as in ethylene oxide. The earlier epoxy resins used for metal bonding were condensation products of bisphenol A and epichlorohydrin. Curing agents for these resins were various amines and acid anhydrides. Improvements in the working characteristics of epoxies have been made over the years and a wide variety of formulations are now available. They cure by additional polymerization with very little volume change or shrinkage while they harden.

An important advantage of epoxy adhesives is that they can be formulated to

meet a variety of use conditions. They are available as elevated- and room-temperature-setting; their pot life can be varied from a few minutes to an hour or more; they can be used with numerous types of fillers; and can be modified with polysulfide and natural or synthetic rubber to change their elasticity. As practically no solvent or other product is given off during the setting of epoxy adhesives, they have very little shrinkage; thus, they can tolerate much thicker gluelines and are more gap-filling than ordinary adhesives.

For wood gluing, use of epoxy resins has been limited mostly to such special applications as repair work, sometimes in combination with glass fiber for reinforcement. Clean, sanded surfaces have provided better bonds for such applications (in the author's experience) than smoothly planed surfaces. In gluing white oak, Douglas-fir, and Alaska-cedar with a number of commercial epoxy adhesives, better results were invariably obtained on sawn surfaces than on smoothly planed surfaces. In short-term soaking tests (vacuum-pressure impregnation), epoxy adhesive bonds failed on white oak, but several formulations showed promising results on the two softwoods.

Since epoxy adhesives are available in so many varieties for many different applications, and in consistencies from free flowing to thixotropic, close cooperation between producer and user is necessary for best results.

Contact Adhesives

Contact adhesives are generally based on natural or synthetic rubber in organic solvents. Adhesives of this type based on neoprene rubber have found wide use for bonding plastic laminates to plywood or particleboard for counter-tops, restaurant and kitchen tables, and similar products.

Generally, both surfaces to be bonded are spread with glue, the solvent is allowed to evaporate, and only contact pressure is required to form the bond.

Rubber adhesives are unique in that they develop considerable strength immediately upon contact of the surfaces to be bonded. Full joint strength, however, develops rather slowly, and the ultimate strength is generally much lower than for ordinary woodworking glues.

Emulsion-type rubber-base adhesives are also available and their performance is similar to the solvent type in many respects. However, the emulsion types have less resistance to moisture.

Mastic Adhesives

One of the definitions for mastic is "any of various quick-drying pasty cements used for cementing tiles to a wall." To the author's knowledge, the term "mastic adhesive" was first used in connection with wood bonding to describe thick, pasty soybean glue for hot-press plywood. Various adhesives of "mastic" consistency have been marketed over the years. Their basic ingredient was often rubber, but lately compositions based on materials such as polyurethanes, polyesters, silicones, and epoxies have come into use. Mastics are sometimes marketed as "construction adhesives," which could be misleading because they generally provide less rigid bonds than commonly used in laminated timbers and other structural applications.

Because of their gap-filling properties, they do not require close-fitted joints, and have apparently performed well in gluing plywood flooring to joists and bonding an underlayment such as particleboard to structural plywood floors. Increased stiffness and strength have been reported for such bonded systems. But long-term data on the initial benefits gained from such mastic bonds appear to be lacking for most formulations. However, some mastic-type adhesives based on urethane resin have remained elastic for several years when exposed to weather.

The bond strength of the mastic adhesives based on rubber and various synthetic materials is generally much lower

than that of conventional thermosetting wood adhesives, but this would not necessarily limit the usefulness of mastics in applications where high joint strength is not a prerequisite for good performance. Gap-filling properties and ability to retain resiliency over the long term can be highly important.

ADHESIVES OF NATURAL ORIGIN

Adhesives of natural origin—such as animal, casein, soybean, starch, and blood glues—are still being used to bond wood in some plants and shops, but are being replaced more and more by synthetics. Animal glue is probably the “natural” adhesive most widely used, although casein glue is being used a great deal for structural laminating.

Animal Glue

Animal glue is a gelatin adhesive obtained from waste or byproducts of the meat processing and tanning industries. The most common raw materials are hides or trimmings of hides, sinews, and bones of cattle and other animals. Trimmings from the leather industry (from tanned hides) are also utilized.

Glue made from hides is generally of higher grade than glue derived from bones and tendons. However, there is considerable variation in the quality or grades of glue from hides as well as from the other sources. Glues for woodworking, as well as most other uses, are commonly blends of two or more batches from the same stock or from different classes of stock. Source is important only insofar as it affects grade.

Each class of glue is sold in cake, flake, ground, pearl, shredded, and other forms; but the form of the glue is no particular indication of quality. The chief difference between the various forms is in the time required to put the glue into solution. The

finely divided forms absorb water more rapidly and can be dissolved more easily than the cake and flake forms. The higher grade glues in the flake form are usually light in color and nearly transparent. Lower grade glues tend to be dark and opaque.

Color and transparency, however, are not dependable indications of quality because low-grade glues are sometimes bleached. Also, foreign substances such as zinc white, chalk, and similar materials are frequently added to transparent glues to produce what are technically known as opaque glues. The added materials, while they apparently do no harm, do not increase the adhesive qualities. Aside from the fact that they give an inconspicuous glueline in light-colored woods, the “opaque” or whitened glues have no apparent advantage over other glues of the same grade.

Marked improvements have been made over the years in the standardization of methods for grading animal glues for woodworking. The definitely established tests and specifications give the user of animal glues means to insure uniformity and to secure a product suited to his operating needs.

PREPARING ANIMAL GLUE FOR USE

In preparing animal glues for use, a number of precautions must be observed if satisfactory results are to be obtained. The proportion of glue and water should be varied to meet manufacturing conditions. When the right proportions have been worked out, they should be used consistently. The glue and the water should be weighed out whenever a batch is prepared. Clean, cold water should be used and the mixture thoroughly stirred at once to allow a uniform absorption of water by the dry glue and prevent the formation of lumps. The batch should then stand in a cool place until the glue is thoroughly water soaked and softened. The soaking may take

only an hour or two or longer, the time depending upon the size of the particles. The glue should then be melted over a water bath at a temperature not higher than 150° F. High temperature and long, continued heating reduce the strength of animal glue solutions and are to be avoided. The glue pot should be kept covered as much as possible to prevent the formation of a skin or scum over the glue surface.

Strict cleanliness should be maintained for glue pots and spreading equipment as well as tables and floors in the glue room. Old glue soon becomes foul and provides a breeding place for bacteria that cause decomposition, exposing the fresh batches to the constant danger of becoming contaminated. Glue pots should be washed every day and only enough glue for a day's run should be prepared at a time. If these simple sanitary precautions are not observed, poor joints are likely to result.

STRENGTH AND DURABILITY OF ANIMAL GLUE JOINTS

Making uniformly strong joints depends primarily upon having the proper correlation of gluing pressure and glue viscosity at the moment pressure is applied. With animal glue solutions, the consistency depends on cooling and drying effects. For the first few minutes after the animal glue has been spread on the wood, the cooling effect is much more important than the drying; this temperature-viscosity relationship varies with the grade and with the concentration of the glue solution. High-grade animal glues thicken to the proper pressing consistency quicker and at higher temperatures than do low-grade glues of equal concentration. Assuming glues of equal grade, one mixed with less water will thicken more rapidly than one mixed with a greater quantity of water.

Warm animal glues, as they normally exist in the spreader, are too thin for pressing and some thickening must occur before pressure is applied. The best consistency

for pressing exists when the glue is thick enough to form short, thick strings when touched with a finger, but not thick enough to resist an imprint or a depression readily. The thickening time or assembly period is usually fixed by the operating conditions that dictate how much time shall elapse between spreading and pressing. The grade of glue and the proportion of water added in mixing become, therefore, the variables by which the manufacturer can fit the glue mixture to his operating conditions. When once established, the glue grade and proportion of water should be adhered to except when temperature changes in the glue room or wood require a change in the mixture.

When the assembly period is fixed by the operation, and the temperature in the glue room rises, an adjustment must be made to accelerate the speed of thickening. This adjustment can usually be made most easily by mixing less water with the glue.

Strong joints may be made with a number of grades of animal glue, but different gluing conditions must be used according to the grade of the glue. If wood joint tests are made with glues of different grades under a uniform set of gluing conditions, the grade of glue that gives the best results is the one best adapted to the particular gluing conditions employed. The joint test results are not necessarily an accurate measure of the inherent strengths of the other grades tested.

With respect to maintaining strength over the long term, animal glue in three-ply birch plywood joints showed no significant loss in strength after 5 years' exposure at 80° F. and 65 percent relative humidity. Cycling of similar specimens between 65 percent relative humidity and 30 percent relative humidity produced very little strength loss in the joints. This is the approximate change in moisture content that can be expected in interior woodwork in normal use in heated buildings in the northern part of the United States. In this type of service, properly designed and well-made joints of animal glue should

give long-term satisfactory performance, particularly if the glued products have a reasonably good moisture-excluding finish. Such a finish retards moisture changes and thus reduces the rate of stresses induced by shrinking and swelling.

Furniture and other products glued with animal glues often serve satisfactorily in spite of occasional exposures to relative humidities up to 80 percent or more. Protection afforded by the finish usually prevents the moisture content of the wood from reaching equilibrium values, particularly if the exposure to dampness is not prolonged. Degradation of the joints is more apt to occur with dense, high-shrinkage species than with lighter species that exert lower stresses on the glue joints.

Casein Glue

Casein glue has been used in Europe for at least a century and in the United States for more than two-thirds of a century. The basic constituent of casein glue is dried casein which, when combined with alkaline chemicals (usually lime and one or more sodium salts), is water soluble.

For some uses, the principal requirements of casein glue are water and mold resistance combined with adequate dry strengths. For other applications, it is desirable to formulate a less expensive casein glue that possesses low staining tendencies, long working life, high dry strength, or good spreading characteristics, even at some sacrifice of water resistance. The glue supplier can produce, therefore, a variety of casein glues of different properties from which the user may choose according to his needs.

PREPARATION OF CASEIN

When milk becomes sour, it separates into curd, the chief protein constituent, and whey. The curd, after being washed and dried, is the casein of commerce. When formed in this way, it is known as naturally soured casein. Casein is also

precipitated by mineral acids, such as hydrochloric or sulfuric, and by rennet. In preparing the glue, caseins precipitated by different methods require different amounts of water to produce solutions of similar viscosity. Satisfactory glues can be produced from caseins precipitated by any of these methods, provided the casein is of good quality.

The starting point in the manufacture of casein is skim milk—that is, whole milk from which the fat has been removed in the form of cream. The usual steps in the manufacturing process are: (1) Precipitation of the casein; (2) washing the curd to remove the acid and other impurities; (3) pressing the damp curd, wrapped in cloth, to remove most of the water; (4) drying the curd; and (5) grinding it to a powder. The care with which these steps are carried out determines the quality of the finished product.

FORMULATION OF CASEIN GLUES

The principal ingredients of a casein glue are casein, water, hydrated lime, and sodium hydroxide. A properly proportioned mixture of casein, water, and hydrated lime will yield a glue of high water resistance, but its working life will be very short. A glue can also be prepared of casein, water, and sodium hydroxide. When properly prepared, such a glue will have excellent dry strength and a long working life, but it will not have the water resistance ordinarily associated with casein glues. By adjusting the proportions of sodium hydroxide and lime, glues of high water resistance and convenient working life may be obtained.

Casein glues containing sodium hydroxide and hydrated lime cannot be mixed in dry (solid) form and shipped. The hygroscopic properties of sodium hydroxide prevent storing a casein glue containing it without danger of decomposition. The alkali can be introduced in an indirect manner, however, so that the casein can

be mixed with all the necessary ingredients, except water, in the form of a dry powder that can be handled and stored conveniently. One way is to replace the sodium hydroxide with chemically equivalent amounts of calcium hydroxide and a substance that, when dissolved in water, reacts with the calcium hydroxide to form sodium hydroxide. Any convenient sodium salt of an acid whose calcium salt is relatively insoluble may be used, provided it is not hygroscopic and does not react with the lime or the casein when the mixture is dry.

Prepared casein glues. -Most manufacturers of wood glues furnish casein glues containing the required ingredients in powder form ready to mix with water. They are prepared for use by merely sifting them into the proper amount of water and stirring the mixture. They usually contain the essential ingredients of casein, hydrated lime, and sodium salt, and are occasionally formulated to reduce staining, hardness, or to impart other properties. Many of the formulas were protected by patents, most of which are now outdated. Directions for mixing these glues with water are usually furnished by the manufacturer

Wet-mixed casein glues. —Some glue users may prefer to mix the ingredients directly from the basic materials—casein, sodium hydroxide, and lime. Approximately the following proportions of ingredients should be mixed in this order.

<i>Ingredients</i>	<i>Parts by weight</i>
Casein	100
water	150
Sodium hydroxide	11
water	50
Calcium hydroxide (hydrated lime)	20
Water	50

This glue remains usable for some 6 to 7 hours at temperatures between 70° and 75° F. It is capable of producing joints

that will have good dry strength and water resistance.

Sodium silicate may be used in place of sodium hydroxide or in place of dry sodium salts, and a glue so prepared will differ from one prepared by the formula above. Particularly, a much longer working life is obtained with a glue using sodium silicate and having alkalinity equal to that obtained by the use of sodium hydroxide or other sodium salts. There is a considerable range of permissible lime content (above that necessary to react with the sodium silicate); however, the working life decreases as the proportion of calcium hydroxide increases.

A small amount of cupric chloride in casein glue has been found effective in increasing the water resistance. This improvement is most striking in glues that do not contain as much lime as required for optimum water resistance. It is not always advisable to use the maximum amount of lime because high-lime glues almost invariably have a short working life. In such cases, it may be expedient to obtain high water resistance by adding copper chloride rather than the maximum amount of lime.

USE CHARACTERISTICS OF CASEIN GLUE

Casein glue sets as a result of chemical reaction and loss of moisture to wood and air. Hence, its rate of setting is affected by the temperature of the wood and surrounding atmosphere, the moisture content of the wood, and other factors. Longer setting time is required in a cold shop than in a warm one, and wood high in moisture content will retard the setting rate.

Casein glue will set at a temperature almost as low as the freezing point of water, but the setting period required to develop strong joints at such temperatures varies from several days to several weeks. The time depends also on the species glued. The wet strength developed at low tem-

peratures may never be as good as that developed at normal room temperatures. A pressing period of 4 hours at 70° F. is considered a minimum for straight members; for curved members, a somewhat longer period is desirable.

Casein glue will produce adequate bonds with wood at a wide range in moisture content—from about 2 to 18 percent. To avoid serious shrinking or swelling stresses on the joints, however, the moisture content of the wood at the time of gluing should be slightly lower than the average expected in service.

DURABILITY OF CASEIN GLUE

Well-made casein glue joints will develop the full strength of most low- and medium-density woods in shear parallel to the grain and will retain a large part of their strength even when submerged in water for a few days. With dense woods, however, casein glue develops only medium to low wood failure percentages when the joints are tested in shear (fig. 15)

To improve resistance to deterioration caused by molds or other micro-organisms,

preservatives are sometimes added to casein glues. Federal Specification MMM-A-125 gives minimum requirements for water- and mold-resistant casein glues. Prolonged exposure to conditions favorable to mold growth or other micro-organisms, however, will eventually result in failure even in joints made of casein glue containing preservative.

Outdoors or where high humidities, either continuous or intermittent, are involved, casein glue joints are not durable. Casein glues containing preservatives have shown greater resistance to high humidities than have unpreserved caseins, but the preservative did not prevent eventual destruction of the glue bonds under damp conditions. Consequently, casein glue is not considered suitable for glued products intended for exterior use, or for interior use where the moisture content of the wood may exceed 18 percent for repeated or prolonged periods. Voluntary Product Standard PS 56 for structural glued laminated timbers limits casein-glued material to service where the equilibrium moisture content of the wood does not exceed 16 percent.

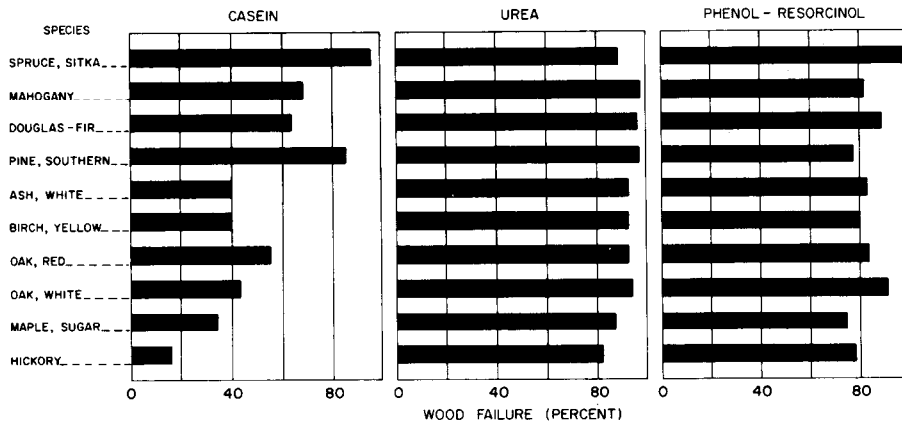

M 132 434

Figure 15.— Percentage failure in wood of various species glued with casein, urea resin, and phenol-resorcinol resin when joints were tested in block shear (ASTM D 905). With both resins, the joints were about as strong as the wood; with casein, a large percentage of the failures in the denser species were in the glue, indicating that the glue bond was the weakest link.



M 138 199-4

Figure 16.— Building erected in 1935 with casein glued-laminated arches. It is currently used for packaging research at the Forest Products Laboratory. Arches are in excellent condition.

Casein glue joints have demonstrated good resistance to dry heat. Results of test exposures to temperatures as high as 158° F. for periods up to 4 years have indicated that the glue bonds in birch plywood are about as resistant as the wood to this type of exposure. Temperatures that char and burn wood cause decomposition of casein glue. Charred wood exposed to fire, however, conducts heat to its interior very slowly so that softening of casein glue joints takes place only next to the zone of char.

Laminated softwood structural members bonded with casein glue have given excellent service when protected from exterior and damp conditions for 35 years

or more in the United States (fig. 16). In Europe, similar structures that are much older are not uncommon. This should be adequate basis for confidence in casein glue as a structural bonding agent for softwood laminates used under normally dry interior conditions.

In joints where the grain of the pieces bonded is not parallel, casein glue has not performed neatly as well, particularly with dense wood having high shrinkage.

Soybean Glue

Soybean glue was introduced to the plywood industry in the Pacific Northwest during the early 1920's, and for many

years was the major glue used for making softwood plywood (interior type—no practical exterior glue had yet been developed). The protein constituents of soybean glue that supply the adhesive properties are somewhat similar to those of casein.

The basic adhesive material in this glue is the protein from soybeans. The oil is first removed from the bean by expeller or solvent processes. The coarse meal is then usually passed through a roller mill (smooth rolls) to crush the shell loose from the kernel. The kernel is ground to the desired particle size, usually in a hammer-mill. The flour is mixed with small amounts of chemicals and is then ready for shipment (usually in 100-lb. bags) to the plywood plant.

Soybean glue almost always is used as a wet-mix glue. Usually, the glue powder is first mixed with sufficient water to make a smooth dough free of dry lumps. Then additional water is added slowly with the mixer running. If the required additional water is added all at once, the dough might break up into lumps, making it nearly impossible to obtain a final smooth mixture. Slaked lime, caustic soda solution, and sodium silicate are usually added to the mix in that order with short periods of mixing between the addition of each ingredient. To prevent or reduce foaming, a small amount of pine oil or other defoaming agent is usually added to the glue mix.

Directions for mixing and the amount of each ingredient to be added are furnished by the glue manufacturer.

Softwood plywood well glued with soybean glue is roughly comparable in water resistance to balsa or similar density plywood bonded with casein glue, and is generally considered satisfactory for normally dry interior service. Soybean glue has not proved entirely satisfactory for gluing hardwoods, particularly the denser ones.

Soybean glue is generally not recommended for hardwood plywood; if both

casein and soybean glues are used for making plywood of the same species, soybean glue generally shows the poorer water resistance. However, it is appreciably superior to starch glues in resistance to moisture and high humidity.

As the standards for performance of plywood have become stricter over the years, it increasingly has become common practice to fortify soybean glue with a certain amount of dried blood or occasionally casein—casein if the plywood is cold pressed and blood if it is hot pressed. Since softwood plywood is being produced more and more by hot pressing, the blood-fortified soybean glues are predominant.

Blood Glue

Glues made of soluble dried blood or blood albumin have been used to some extent in the United States, but they are more common in some European and Asiatic countries.

Blood albumin, a slaughterhouse by-product, coagulates and sets firmly when heated to a temperature of about 160° F. It then shows a significant resistance to the softening effect of water. This characteristic makes it a desirable material for glue to use in products such as plywood.

A number of patents have been granted on glue formulations based on blood. As with other protein glues, alkalis such as caustic soda, hydrated lime, sodium silicate, or combinations of these are employed in formulating blood glues. Thermosetting resins (usually phenolic) are also sometimes incorporated to increase the resistance of the glue bonds to degrading influences.

Hot-press blood glues are probably the most resistant of the protein-type glues to weathering and similar severe service but are not recommended for long-term exterior use as are the phenols and resorcinols and some other synthetics.

SELECTED REFERENCES

- American Society for Testing and Materials
Standard method of test for strength properties of adhesive bonds in shear by compression loading. Des. D 905. (See current edition) Philadelphia, Pa.
- Blomquist, R. F.
1964. Durability of fortified urea-resin glues exposed to exterior weathering. *For. Prod. J.* 14(10):461-466.
- Blomquist, R. F., and Olson, W. Z.
1957. Durability of urea-resin glues at elevated temperatures. *For. Prod. J.* 7(3):266-272.
- Carlson, Herbert E.
1962. Bonding with hot melts. *Adhes. Age* 5(11):32-33.
- Carroll, M. N., and Bergin, E. G.
1967. Catalyzed PVA emulsions as wood adhesives. *For. Prod. J.* 17(11):45-50.
- Carruthers, J. S.
1958. The comparative durability of assembly glues in England and Nigeria. *Dep. of Sci. and Ind. Res., For. Prod. Res. Lab., Princes Risborough, England*
- Cheo, Y. C.
1969. Hot melt coatings for wood products. *For. Prod. J.* 19(9):73-79.
- Cone, Charles N.
1959. Resin-blood glue and process of making the same. U.S. Pat. No. 2,895,928. 8 p. July 21.
- Fotsyth, Robert S.
1962. New developments in synthetic resin hot melts. *Adhes. Age* 5(8):20-23.
- Freeman, H. G., and Kreibich, R. E.
1968. Estimating durability of wood adhesive in vitro. *For. Prod. J.* 18(7):39-43.
- Gillespie, R. H., Olson, W. Z., and Blomquist, R. F.
1964. Durability of urea-resin glues modified with polyvinyl acetate and blood. *For. Prod. J.* 14(8):343-349.
- Hartman, Seymour
1970. High temperature adhesive. *For. Prod. J.* 20(12):21-23.
- Kopyscinski, Walter, Norris, F. H., and Herman, Stedman
1960. Synthetic hot melt adhesives. *Adhes. Age* 3(5):31-36.
- Kreibich, R. E., and Freeman, H. G.
1970. Effect of specimen stressing upon durability of eight wood adhesives. *For. Prod. J.* 20(4):44-49.
- Kreibich, R. E., and Freeman, H. G.
1965. Testing adhesives for creep can provide data on adhesive systems which will help improve structural bondants. *Adhes. Age* 8(8):29-34.
- Lee, Henry, and Neville, Kris
1967. *Handbook of epoxy resins.* McGraw-Hill Book Co., New York.
- McGrath, J. J.
1967. Hot melts featured at adhesive meeting. *For. Prod. J.* 17(4):22.
- Northcott, P. L., and Hancock, W. V.
1966. Accelerated tests for deterioration of adhesive bonds in plywood. *Durability of Adhesive Joints, Spec. Tech. Publ. No. 401.* 62-79. Am. Soc. Test. Mater., Philadelphia.
- Olson, W. Z.
1955. Polyvinyl-resin emulsion woodworking glues. *For. Prod. J.* 5(4):219-226.
- Olson, W. Z., and Blomquist, R. F.
1962. Epoxy-resin adhesives for gluing wood. *For. Prod. J.* 12(2):74-80.
- Picotte, Gordon L.
1965. "Toughness" of structural adhesives. *Adhes. Age* 8(2):21-23.
- Rundle, V. A.
1969. Hot-melt coatings for wood products. *For. Prod. J.* 19(9):73-80.
- Selbo, M. L.
1969. Performance of southern pine plywood during 5 years' exposure to weather. *For. Prod. J.* 19(8):56-60.
- Selbo, M. L.
1965. Performance of melamine resin adhesives in various exposures. *For. Prod. J.* 15(12):475-483.
- Selbo, M. L.
1958. Curing rates of resorcinol and phenol-resorcinol glues in laminated oak members. *For. Prod. J.* 8(5):145-149.
- Selbo, M. L.
1949. Durability of woodworking glues for dwellings. *Proc. For. Prod. Res. Soc.* 3:361-380.
- Selbo, M. L.
1949. Glue joints durable in beams laminated of common lumber. *South Lumberman* 179(2244):60-62.
- Selbo, M. L., Knauss, A. C., and Worth, H. E.
1965. Glulam timbers show good performance after two decades of service. *For. Prod. J.* 15(11):466-472.
- Selbo, M. L., and Knauss, A. C.
1958. Glued laminated wood construction in Europe. *Proc. Am. Soc. Civil Eng.* 84(ST 7). 19 p. Nov.

- Selbo, M. L., Knauss, A. C., and Worth, H. E.
1966. Twenty years of service durability of pressure-treated glulam bridge timbers. *Wood Res. News* 44(3):5-16, Part I; 44(4): 10-14, Part II.
- Selbo, M. L., and Olson, W. Z.
1953. Durability of woodworking glues in different types of assembly joints. *For. Prod. J.* 3(5):50-57.
- Simpson, W. T., and Soper, V. R.
1970. Tensile stress-strain behavior of flexibilized epoxy adhesive film. USDA For. Serv. Res. Pap. FPL 126. 13 p. U.S. Dept. Agric. For. Serv. For. Prod. Lab., Madison, Wis.
- Skeist, Irving
1964. Modern structural adhesives for use in the building industry. *Adhes. Age* 7(4):21-26.
- Troughton, G. E.
1967. Kinetic evidence for covalent bonding between wood and formaldehyde glues. *Inf. Rep. No. VP-X-26*, 22 p. For. Prod. Lab., Vancouver, B.C.
- Truax, T. R., and Selbo, M. L.
1948. Results of accelerated tests and long-term exposures on glue joints in laminated beams. *Trans. Am. Soc. Mech. Eng.* 70:393-400. May.
- Twiss, Sumner B.
1965. Structural adhesive bonding. Part II: Adhesive classification. *Adhes. Age* 8(1):30-34.
- U.S. Department of Commerce
1973. Structural glued laminated lumber. Voluntary Prod. Stand. PS 56-73. Natl. Bur. Stand., Washington, D.C.
- U.S. Forest Products Laboratory, Forest Service
1967. Casein glues: Their manufacture, preparation, and application. U.S. For. Serv. Res. Note FPL-0158.15 p. U.S. Dept. Agric., For. Serv. For. Prod. Lab., Madison, Wis.
- U.S. Forest Products Laboratory, Forest Service
1963. Durability of water-resistant woodworking glues. Rep. 1530. 41 p. U.S. Dept. Agric. For. Serv. For. Prod. Lab., Madison, Wis.
- U.S. General Services Administration
1969. Adhesive, casein-type water and mold resistant. Fed. Specif. MMM-A-125. Fed. Supply Serv., Washington, D.C.
- Williamson, D. V. S.
1965. Hot melt adhesives in Europe. *Adhes. Age* 8(8):24-27.
- Williamson, F. L., and Nearn, W. T.
1958. Wood-to-wood bonds with epoxide resins-species effect. *For. Prod. J.* 8(6): 182-189.

IMPROVING PERFORMANCE OF WOOD THROUGH GLUING

To produce high-quality, adhesive-bonded wood products, it is not only important to know and understand the properties and use characteristics of the adhesive, *it is equally important to know how to select, prepare, and use the wood so that it will serve to the best advantage.*

Wood has good stability and excellent strength properties in the grain direction. Across the grain it is stable at constant moisture content but shrinks with decreases in moisture and swells with increases in moisture. Normal straight-grained wood of some species may also split or check along the grain when subjected to rapid reductions in moisture content.

Both resistance to splitting and uniformity in strength properties can be improved by gluing together sheets or layers of wood with the grain in adjacent layers at approximately 90° (plywood).

By gluing together layers all having the grain approximately parallel (laminating), the strength in bending and in tension in the direction of the grain can be improved. Two-by-fours laminated from low-grade veneers can be produced with much more uniform strength properties than solid structural 2 by 4's. This is accomplished by dispersion of strength-reducing defects.

By end-joint gluing, material of any desired length can be obtained; and by edge gluing, any desired width is obtainable.

CROSSBANDED CONSTRUCTION

Crossbanded construction includes a large variety of panel products consisting usually of an odd number of layers of wood glued together with the grain in adjacent layers at an angle of about 90°. Plywood, the most common form of crossbanded construction, is defined as a crossbanded assembly made of layers of veneer or veneer in combination with lumber or other core materials and joined with an adhesive. The plywood constructions probably most widely used are veneer plywood and lumber core plywood. The term “veneered panels” is often used for lumber core plywood. A veneered panel could also have a particleboard core (fig. 17), with or without crossbands. Flush doors are generally of crossbanded construction.

The bulk of softwood plywood production goes to structural applications

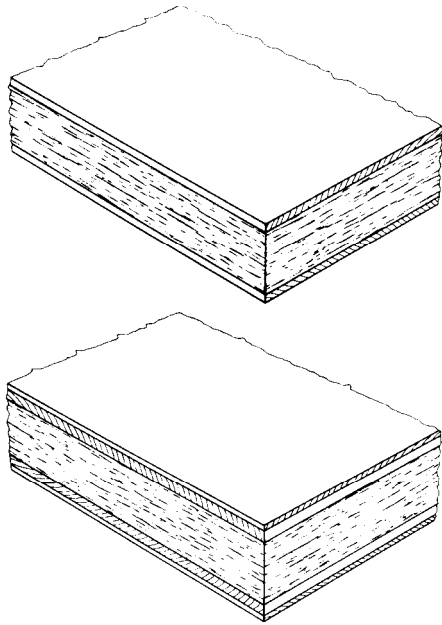

M 138 529

Figure 17.— Three- and five-ply veneered panels with particleboard cores.

(housing, concrete forms, packaging). Hardwood plywood goes to furniture, paneling, and other uses. Several types of plywood are shown in figures 18, 19, and 20. Veneer plywood is most commonly made and used as flat panels (figs. 18 and 19). It may also be made as flat panels and later bent or formed within limits as may be required (fig. 20, A). Plywood with sharp or compound curves may be formed by pressing the veneers (coated with glue) in molds of the desired shape and curing the glue with radio-frequency energy or other types of heat. As a rule, curved plywood formed to the desired shape during manufacture is more stable than plywood bent to form later.

Most plywood is three or five ply. In three-ply construction, the two outside plies are called faces, or face and back, and are usually laid at right angles to the grain of the center ply or core (fig. 18, A). In five-ply panels the outside plies are also called faces, or face and back, and the center ply is the core (fig. 18, B). The second and fourth plies are termed the crossbands and are usually at right angles to the grain of the face, back, and core. Plywood construction other than three- or five-ply may be used, but odd numbers of plies are generally symmetrically arranged on each side of the core. The core may be veneer, lumber, or various combinations of veneer or lumber laminated so that they act as a single ply (fig. 19, A, B, C, D). In recent years it has been found advantageous to make panels of four veneers. The two center ones are glued together with the grain parallel and serve as the core in a three-ply panel. In a similar manner three or more laminated veneers could serve as core. Panels may range in total thickness from less than one-eighth inch to more than 3 inches. They may vary in number and thickness of plies, kinds and combinations of woods, and durability of the glues required for various service conditions.

The chief advantages of plywood as compared with solid wood are: (1) Greater

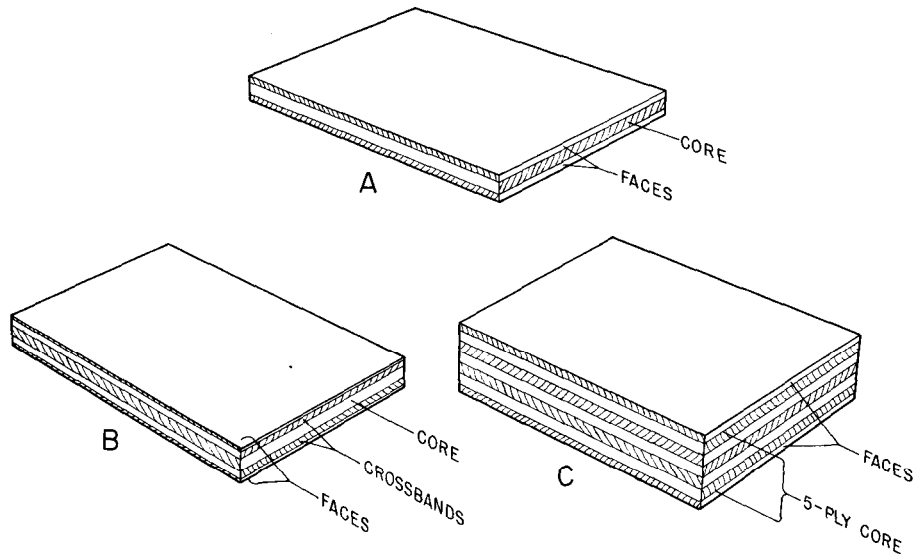

M 138 743

Figure 18.—Three constructions of all-veneer plywood: A, three-ply; B, five-ply; and C, seven-ply.

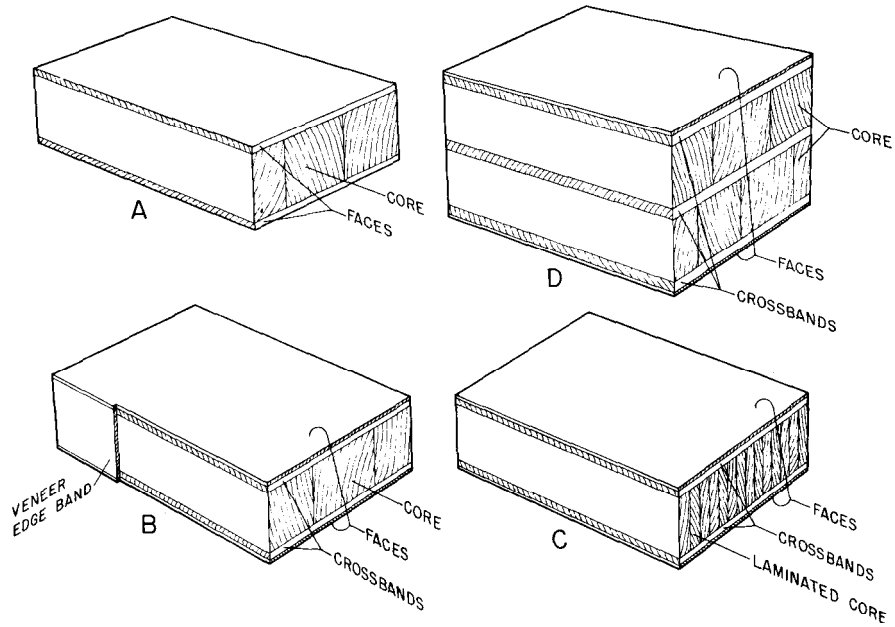

M 138 746

Figure 19.— Three different constructions of lumber core plywood and one with laminated veneer core: A, three-ply; B, five-ply, with veneer edge banding; C, seven-ply, with laminated veneer core (used where showthrough must be avoided and good stability is required); and D, extra thick lumber core plywood. Crossband at middle of core reduces dimensional changes of core.

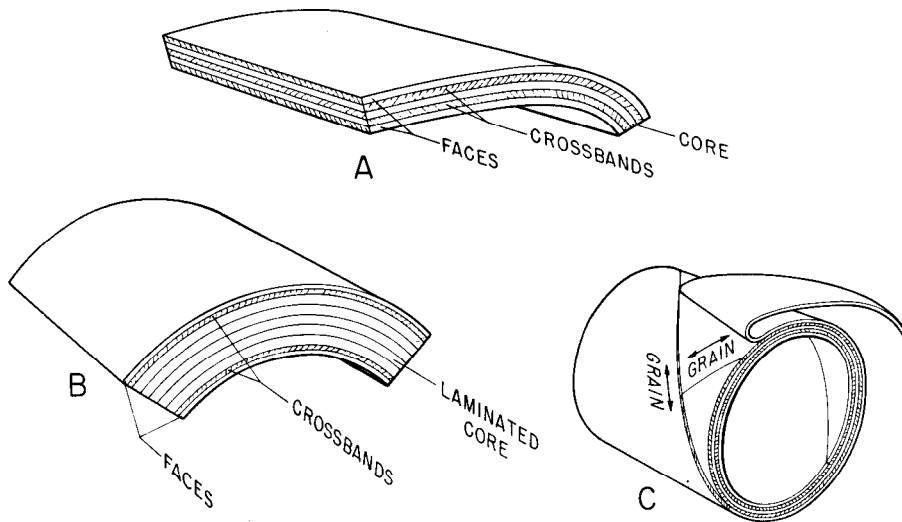

M 138 744

Figure 20.— Three types of curved plywood: A, conventional five-ply, all-veneer plywood bent to form; B, laminated core with veneer crossbands and faces; and C, five-ply, spirally wrapped plywood tubing.

resistance to splitting and checking, (2) more nearly equal strength properties along the length and width of the panel, (3) dimensional changes with changes in moisture content that are more nearly equal in length and width and distinctly less than the changes of solid lumber in width, and (4) the plywood production processes utilize wood more efficiently.

These advantages are present because the direction of the grain of each ply is generally at right angles to that of adjacent plies. The strength of a piece of lumber or veneer along the grain is much greater than the strength across the grain. When pieces are glued together with the direction of their grain at right angles, the high strength and dimensional stability of each piece along the grain resist the stresses and movement of adjacent pieces across the grain, and the strength and stability of the panel in the two directions are, in effect, equalized. The result is a more nearly homogeneous product than solid wood. Because of the cross plies, plywood panels are very resistant to splitting in planes at

right angles to the plies. Along planes parallel to the plies, the splitting characteristics resemble those of solid wood.

The glued, crossbanded product, therefore, is more nearly constant in width and length under varying moisture conditions. It is not necessary that the cross plies be thick or that they occupy a very large part of the total thickness of the crossbanded product. In a five-ply veneered panel with a core of nominal 1-inch lumber and face and back of 1/28-inch veneer, for example, the crossbands are frequently of 1/20-inch veneer. The choice of thickness depends on the tensile strength of the species. The crossbands must be sufficiently strong in tension parallel to grain to withstand, without breaking, the stresses developed by the core when it tends to expand or contract as the moisture content changes.

To realize fully the advantages of crossbanded construction, the panels must be properly designed and glued. The tendency of panels to cup and twist may be greater in improperly constructed plywood than in the average panel of solid wood of

the same thickness. Crossbanded panels may be considered to be relatively free from stress at the time the glue sets. When the moisture content changes thereafter, however, adjoining plies try to shrink or swell in directions at right angles to each other but each ply restrains the ply or plies next to it. Since the moisture in the panel during service is rarely distributed as it was when the glue set, plywood panels may be considered as continually under stresses that tend to rupture the glue joints or to distort the panel. The further the moisture content departs from that existing when the glue set, the greater will be the stresses developed. The development of these stresses cannot easily be prevented but their magnitude and effect can be largely controlled by choice of species, proper design, well-glued joints, and control of moisture content at the time of gluing.

In crossbanded products that are properly designed, the forces exerted by the plies on one side of the core balance in magnitude and in direction the forces exerted by the plies on the other side of the core. This balance is partly accomplished by the use of an odd number of plies so arranged that for any ply on one side of the core there is a corresponding parallel ply on the other side at the same distance from the core.

In addition to being correctly spaced from the core, the wood in corresponding plies should have the same shrinkage and density properties to obtain a balanced effect. The shrinkage of wood varies with the species and the method of cutting, and the stresses developed vary with the density. In some cases, the difference in shrinkage between edge-grained wood and flat-grained wood of the same stock is greater than between similarly cut wood of different species. Consequently, flat-grained and quartered material of the same wood may not balance so closely as woods of different species. For best results, therefore, corresponding plies should be of the

same species, of similar density, and cut in the same manner.

Since the outer plies of a crossbanded construction are restrained on only one side, changes in moisture content induce relatively larger stresses in the outer glue joints. The magnitude of stresses depends upon such factors as thickness of plies, density, shrinkage of the woods involved, and the amount of the moisture content changes. In general, one-eighth inch is the maximum thickness of face plies that can be held securely in place when moderately dense woods are used and large moisture changes occur. For panels where face checking would be objectionable, such as in doors and furniture, thin face veneers (1/28 in. or 1/32 in.) are preferable to thicker ones.

Quality of plies

In thin plywood, the quality of all the plies affects the shape and permanence of form of the panel. For greatest stability all plies should be straight grained, smoothly cut, and of sound wood that is of uniform growth and texture.

In thick, five-ply (lumber core) panels the crossbands in particular affect the stability and quality of the panel. Imperfections in the crossbands, such as marked differences in the texture of the wood, irregularities in the surface, or even pronounced lathe checks, may show through thin face veneers as imperfections in the surface of the panel.

Figured veneer cut from burls, crotches, stumps, and similar irregular material is not straight grained but is used because of its attractive appearance. It shrinks both with the width and length of the sheet, whereas plain veneer shrinks chiefly in width. This difference in shrinkage between the two types of veneer causes warping when they are used as opposing plies in thin panels. With combinations of plain and figured veneer, it is not practical to have a strictly balanced construction and the effect of the unsymmetrical arrange-

ment must be compensated for in some other way. Ordinarily, by laying figured veneer over a thick and properly cross-banded core, the construction is made stiff enough to prevent the unbalanced stresses exerted by the thin faces from excessively warping or distorting the panel. Thick, five-ply veneered panels (fig. 19, *B* and *C*) make it possible to use a figured veneer on the panel face and a straight-grained veneer on the back.

Causes and Prevention of Warping

In a panel that is symmetrical and balanced about its central plane, opposing plies must have about the same moisture content when glued. Variations in moisture content of corresponding plies at the time of gluing bring about shrinkage differences that may result in warping. Large changes in the moisture content of the wood after gluing should be avoided because they induce internal stresses of large magnitude that could cause warping, checking, and weakening of joints.

Warping may be expected if the panel contains veneer that is partially decayed, or veneer that has abnormal shrinkage characteristics, such as exhibited by compression wood or tension wood.

Cross grain or short grain that runs sharply through the crossband veneer from one surface to the other often causes the panels to cup. Cross grain that runs diagonally across the crossband veneer is likely to cause the panel to twist unless the two opposing crossbands are laid with the grain parallel to each other. Failure to observe this simple precaution is the cause of much warping in crossbanded construction. While it is impractical to eliminate all crossgrained veneer, that showing an excessive amount of cross grain should be rejected for most plywood manufacture. It can be used for purposes where its effect is not harmful (cabinet backs, for example).

For certain types of panels that are held securely in place by mechanical means, tendencies toward warping might be unimportant. For others, such as lids and doors that generally are mechanically fastened at one edge, even a small amount of warp might be objectionable. In panel products, twisting and cupping are the most common types of warping.

TWISTING

Corresponding plies on opposite sides of the core should not only swell or shrink in the same direction, but the stresses should be of the same magnitude. If the stresses are not balanced with respect to direction, the distortion that results frequently is twist, a form of warping in which the four corners of the panel will not rest simultaneously on a flat surface.

Generally, twisting in plywood is related to grain direction. While factors other than grain direction can cause twisting, they are not so frequently encountered in practice. If plywood or veneered tops, unattached to supporting members, are twisted, it is most likely that grain direction of the panel plies is at fault.

In five-ply veneered panels with comparatively thick cores and thinner crossbands and faces, the crossbands are the most essential element in maintaining a panel free from twist. In this construction, the grain of the crossband on one side should be parallel to the grain of the crossband on the other side of the core. The amount of variation from this condition that may occur without twisting depends upon such factors as thickness of core, density of core, moisture content of the core at the time of gluing, and change in moisture content after gluing. With thin, experimental panels, a variation of 5° in grain direction of opposing crossbands has caused distinct twisting. Examination of commercial, five-ply veneered panels has often disclosed pronounced twisting with a variation of 15°.

While the crossbands of five-ply construction are usually the critical elements, the faces are critical in three-ply construction. If the crossbands of five-ply, thick core construction are properly laid, variations in the direction of grain of the faces seldom cause objectionable distortion. In five-ply, thin core construction, however, parallel grain is important in the faces as well as in the crossbands.

Ordinarily, the causes of twisting are easily detected. To avoid or reduce twisting that occurs when grain direction of plies is not parallel, changes in manufacturing procedure are usually required. One of the simplest and least costly methods of reducing twisting is to select for crossbands such species as basswood, aspen, and yellow-poplar that generally produce reasonably straight-grained stock. If the value of the product justifies the added cost, the veneer should be clipped and trimmed parallel and perpendicular to the grain rather than parallel and perpendicular to the axis of the veneer bolt. Since adjacent pieces of sliced veneer are very similar in grain formation, twisting may be reduced or avoided by using two adjacent pieces of sliced veneer for the two crossbands of one panel. They must be laid with the grain parallel to each other in the panel. The same principle could be applied to rotary-cut veneer for crossbanding by properly marking and arranging the veneer as it comes from the lathe to insure that matching sheets would be used for the two crossbands of a panel. Such precautions, however, may or may not be practical in a commercial operation, depending on the cost of the final product.

If a panel changes in moisture content to a marked degree at the edge while the center changes very little, the stresses developed may cause twisting. This condition can be detected by determination of the moisture content at the edges and at the center of the panel. Much of the twisting will probably disappear when the panel is reconditioned to a uniform moisture content. Twisting has also been observed

when plywood panels were fastened rigidly (particularly if glued) to supporting members or frames whose shrinkage characteristics differed from those of the plywood panel.

CUPPING

Ordinarily, the exact cause of cupping is much more difficult to establish than the cause of twisting. However, cupping difficulties are often more easily eliminated in commercial operations than are the causes of twisting.

Cupping generally results from forces that restrain the core unequally on the two sides. If, for example, a crossband was glued to only one side of a core, the core would be greatly restrained on one side in its movements with moisture changes but not at all on the other side, and cupping would surely result. The direction of the cupping would depend on whether the core increased above or dried below the moisture content it had when the glue set. If the crossband on one side differs distinctly in shrinkage characteristics or strength properties (along the grain) from the corresponding crossband on the other side, cupping may be expected. A few of the more common causes are:

1. Crossband on one side thicker than on the other. When the core attempts to change dimensions under changes in moisture content, the movement of the core will be restricted more strongly on the side with the thicker crossband (assuming both crossbands are of the same or similar species) and cupping will result. Unequal sanding of the faces of a three-ply panel produces an effect similar to that caused by the use of faces of unequal thickness. Minor variations in the thickness of thin faces on five-ply, lumber-core panels will not ordinarily cause objectionable distortion.

2. Short-grained crossband on one side and a straight-grained crossband on the other. When the grain of a sheet of

veneer dips abruptly through the sheet from one surface to the other, the sheet will have greater shrinkage in length than a sheet in which the grain is parallel to the plane of the sheet. If such a short-grained sheet is laid as one crossband and a straight-grained sheet as the opposing crossband, the short-grained sheet will not offer the same resistance to the movement of the core as the straight-grained one and cupping will result.

3. Partially decayed crossband on one side and a sound crossband on the other. When the core shrinks or swells under moisture changes, the decayed crossband offers less resistance to the dimensional changes of the core than the sound crossband and cupping results.

4. Reaction wood in one crossband and normal wood in the other. One of the characteristics of reaction wood is a high degree of longitudinal shrinkage as compared with normal wood. If a sheet of veneer containing reaction wood is laid as one crossband and a sheet of veneer of normal wood as the other, the sheet containing reaction wood will tend to shrink or swell longitudinally while the corresponding crossband of normal wood will tend to remain more nearly fixed in the lengthwise direction. Consequently, the core will be restrained unequally on the two sides and cupping will result. If a crossband contained both reaction wood and normal wood, distortion in the form of combined twisting and cupping might result.

In exterior flush doors it is conceivable that longitudinal shrinkage of the inner face and longitudinal swelling of the outer face, during the cold season, could also contribute to cupping.

HANDLING AND FABRICATION

It is quite possible that well balanced and properly constructed plywood will warp because of methods used in handling

or storing the plywood or because of the way in which the plywood is built into the finished item.

One rather common cause of warping that is not related to grain direction or quality of plies is permitting plywood to dry (or to regain moisture) more rapidly from one side than from the other. It has been observed frequently that the top panel of a pile of panels will be warped because it dried more rapidly from the upper surface than from the bottom. When panels are piled solidly, the top of the pile should be kept covered to prevent rapid loss or regain of moisture by the top surface. If considerable change in moisture content is expected, it is often desirable to protect the ends and edges of the panels from rapid changes in moisture content.

When a finish that is highly resistant to the passage of moisture is applied to one side of the panel and either no finish or one low in resistance to moisture movement is applied to the other, moisture will move in or out of one surface more rapidly than the other. In this case, cupping may result just as when panels are allowed to dry more rapidly from one surface than from the other.

While plywood shrinks and swells much less than normal wood does in either the tangential or radial direction, it shrinks and swells more than normal wood does in a longitudinal direction. A plywood panel that is fastened firmly to a longitudinal supporting member, therefore, may warp or pull loose from the fastenings under severe changes in moisture content. If the design requires a fastening between plywood and framing members, provision should be made wherever possible to permit a slight movement of the plywood relative to the supporting member just as a solid tabletop is ordinarily fastened to the frame to permit a slight swelling or shrinking of the top. Softwood plywood glued to studs in walls of houses or mobile homes usually does not change enough in moisture content to cause any warping problems.

REQUIREMENTS FOR CROSSBANDS

If the flatness of plywood is an important consideration, as often is the case with furniture plywood, one of the essential requirements of good crossbanding veneer is straightness of grain. Of the straight-grained species that have been available in quantity and sizes suitable for veneer cutting operations, yellow-poplar has been a favorite.

If the crossbanding is to be laid under thin face veneers, it should be uniform in texture and free from defects. Species that show marked contrast between the earlywood and latewood, such as Douglas-fir and southern pine, are less desirable than those in which the contrast between earlywood and latewood is slight, such as basswood, aspen, and yellow-poplar. The defects that can be permitted in the crossbanding depend upon the thickness of the face veneer and upon the quality of finish demanded. A high-gloss finish will accentuate minor surface irregularities much more than a matte finish. If the thickness of the face veneer is about one twenty-eighth inch, as often used, and if a finish that shows no irregularities under reflected light is desired, the crossbanding must be essentially free from defects and the edge joints must be tightly glued.

When the plywood panels are thin (one-fourth inch or less, they can be more easily distorted by the shrinking or swelling of the crossbands, and low shrinkage characteristics and low specific gravity of crossbands become desirable properties. For lumber core panels, the specific gravity and the shrinkage characteristics of the crossbands are probably less important so long as one crossband balances the other and stresses do not cause rupture of adjacent glue bonds.

The limited supply of species that possess all or nearly all of the desirable characteristics for crossbanding necessitates the use of less desirable species. Sweetgum and tupelo, for example, are frequently

used for crossbanding although they are not so inherently straight in grain as might be desired. Birch and maple have been used although they are comparatively high in specific gravity and somewhat irregular in grain direction. Even though the less desirable species are used for crossbanding, satisfactory items can be produced if the characteristics of the species are recognized and the operating procedures adjusted to compensate for some of the deficiencies. For instance, a thinner veneer of high tensile strength can be substituted for a thicker one lower in strength.

Table 2 shows the average shrinkage and density values of some woods commonly used for plywood and veneered panels. Shrinkage data for quartered (radial) and rotary-cut (tangential) stock are shown since some species are manufactured and used extensively in both forms. The table permits selection of species that have about the same density and percentage of shrinkage. Differences in density between two woods can be compensated for by varying the thickness of the plies in inverse proportion to their specific gravities. This method of compensation results in using a proportionately thicker ply of the lighter species, which might be advantageous in some cases. The practice, however, requires thorough knowledge of the properties of the wood and is not common.

REQUIREMENTS FOR CORES

A high percentage of core total plywood thickness helps maintain a flat, unwarped surface. In general, the core should comprise five- to seven-tenths of the total thickness of a five-ply panel where flatness is important.

When crossbands and face veneers are relatively thin, the cores for high-grade panels must be practically free from knots, knotholes, limb markings (local areas of cross grain occurring in the region of knots), and decayed wood. Unless re-

Table 2 —Average shrinkage and density values of wood commonly glued¹

Common species name	Shrinkage ²		Density ³
	Radial	Tangential	
	<i>Percent</i>	<i>Percent</i>	
Hardwoods			
Alder, red	4.4	7.3	0.41
Ash, white	4.9	7.8	.60
Aspen, quaking	3.5	6.7	.38
Basswood	6.6	9.3	.37
Beech	5.5	11.9	.64
Bitch, yellow	7.3	9.5	.62
Cottonwood, eastern	3.9	9.2	.40
Elm, American	4.2	7.2	.50
Mahogany (<i>Swietenia</i> sp.)	3.7	5.1	—
Maple, red	4.0	8.2	.54
Maple, sugar	4.8	9.9	.63
Oak, northern red	4.0	8.6	.63
Sweetgum	5.3	10.2	.52
Sycamore	5.0	8.4	.49
Tupelo, black	5.1	8.7	.50
Tupelo, water	4.2	7.6	.50
Walnut, black	5.5	7.8	.55
Yellow-poplar	4.6	8.2	.42
Softwoods			
Douglas-fir, coast	4.8	7.6	.48
Fir, white	3.3	7.0	.39
Hemlock, western	4.2	7.8	.45
Larch, western	4.5	9.1	.52
Pine, ponderosa	3.9	6.2	.40
Pine, shortleaf	4.6	7.7	.51
Pine, sugar	2.9	5.6	.36
Redwood, old-growth	2.6	4.4	.40
Spruce, Sitka	4.3	7.5	.40

¹Data from Wood Handbook.

²Shrinkage from green to overdry condition expressed in percent of dimensions when green.

³Density expressed as specific gravity based on oven-dry weight and volume at 12 pct. moisture content.

moved, such defects may be visible on the faces of panels after they have received a finish. The size of defects that may occur in cores without showing upon the finished faces depends largely upon the thickness of the crossband and face veneers. Prevailing commercial practice varies as to the maximum size of knots and blemishes permitted, depending in part upon the quality of finish demanded from the item and in part on how readily minor irregularities in the surface may be detected during the common use of the item. A veneered tabletop, for example, is often

viewed in reflected light that causes even a minor irregularity in the surface to show clearly; on the sides and ends of the same piece, minor irregularities in the surface may be much less conspicuous. Decayed wood has a different shrinkage rate than sound wood and under moisture changes this shrinkage difference may cause noticeable irregularities on highly finished surfaces.

Edge-grained cores are better than flat-grained cores because of their lower shrinkage in width. With most species a core made of all quartersawed or of all-flat-

sawed material remains more uniform in thickness with moisture content changes than one made by combining these two types of material. Use of narrow core strips makes surface irregularities caused by mixed grain (flat sawn and vertical) less obvious. For high-grade cores of softwood it is desirable to use quartersawed stock. If both edge- and flat-grained material or even all flat-grained lumber is used in softwood cores, the panels are more likely to show wavy and irregular surfaces than if the stock is all edge grained. Edge-grained material is more desirable than flat-grained for softwood core stock for the additional reason that the hard bands of latewood are less likely to show through thin face veneers. Mixing species in the same core invites irregularities in the surface because of the differences in the shrinkage characteristics of the different species. It is important, of course, that all pieces in any one core be at the same moisture content when the core stock is surfaced. Otherwise, when the moisture content of the stock equalizes in service, some pieces will swell or shrink more than others and irregularities in the surface will result.

The best core woods for high-grade panels have low density, low shrinkage characteristics, slight contrast between the earlywood and latewood, and are easily glued. Yellow-poplar and basswood as well as several foreign species are desirable core woods. Edge-grained redwood is very satisfactory. Sweetgum and tupelo are used extensively for cores. Ponderosa pine is used extensively for cores in doors. Such cores are commonly built from small pieces of wood which are byproducts of the manufacture of sash and other millwork and are faced with thick veneers. Ponderosa pine, because of its lower density and shrinkage characteristics, is less apt to cause showthrough than denser species.

Many other species are used successfully for core stock even though they may lack some of the most desirable properties. Satisfactory panels can be fabricated even if the most desirable species are not avail-

able for cores. As a general rule, however, the less desirable the species, the more care will be required to fabricate satisfactory panels.

LAMINATED CONSTRUCTION

Glued-laminated or parallel-grain construction, as distinguished from plywood or other crossbanded construction, refers to two or more layers of wood joined with an adhesive so that the grain of all layers or laminations is approximately parallel. The size, shape, number, and thickness of the laminations may vary greatly. Glued-laminated construction may be used as a base or core for veneer, as in doors or tabletops and other furniture panels, or it may be used without veneer covering for chair seats, tabletops, bleacher seats, and bench tops, structural beams and arches (fig. 21), boat timbers, laminated decking, airplane propellers, spars, spar flanges, or for sporting goods items such as baseball bats and bowling pins (fig. 22).

While the properties of glued-laminated products are generally similar to those of

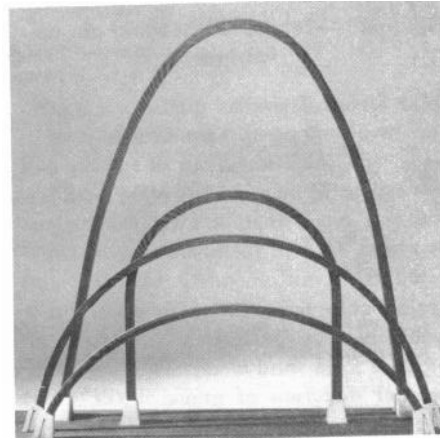

M 118 468

Figure 21.— Model of laminated arches used in churches, gymnasiums, supermarkets, and similar structures.

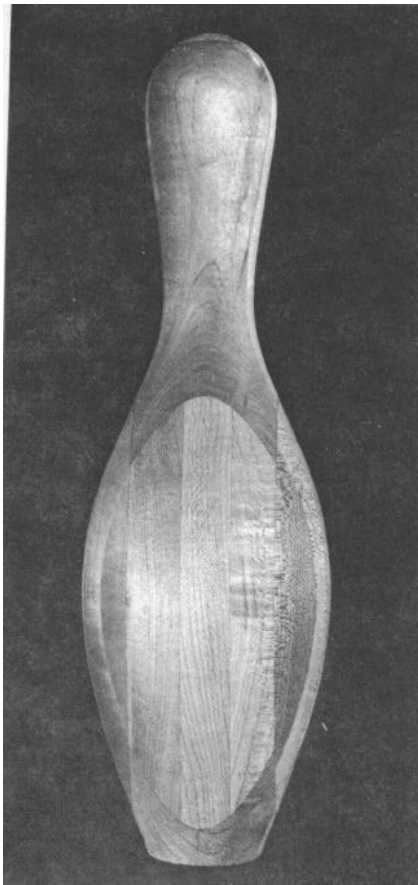

M 138 358

Figure 22.— laminated bowling pin (unfinished).

solid wood of similar quality, manufacture by gluing permits production of long, wide, and thick items out of smaller and less expensive material and often with less waste of wood than if solid wood alone was used. Curved members may be fabricated by simultaneously bending and gluing thin laminations to shapes that would be very difficult or impossible to produce from solid wood. The essentially parallel direction of grain of the wood to the longitudinal axis of these laminated products gives them strength that is often far superior to solid wood cut to the same size and shape. Boat timbers, for example, are laminated in sizes that are no

longer available in solid timbers (fig. 23). The manufacture of glued-laminated beams, arches, and trusses has become a very important segment of the wood industry. Glued structural members that may be used in full exposure to weather as well as those intended for dry service are being produced. Laminated utility poles for power transmission lines are further examples of expanding application of the laminating technique. It seems probable that increasing scarcity of large timbers will lead to further expansion in the use of laminated products even through production of laminated items involves skills and equipment not necessary in producing items from solid wood.

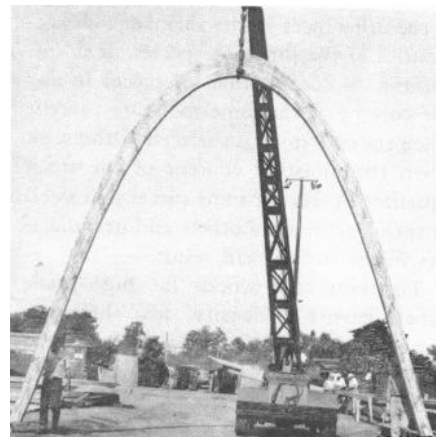

M 994 395

Figure 23.— Laminated white oak ship frame.

Selection of Species and Grades

For many glued-laminated items, the selection of species is partially limited by the properties desired in the finished article. White oak is desired in ship timbers, for example, because it combines excellent properties to hold fastenings with high strength and durability under wet exposures; Sitka spruce is often specified for booms, spars, propellers for wind

tunnels, and masts because of its high strength-weight ratio; and yellow birch is also sometimes favored for small aircraft propellers because of toughness.

Softwood species, principally Douglas-fir, southern pine, western larch, and hemlock, are used largely in laminated arches and beams because of favorable cost, availability, and adequate strength properties. These softwood species are the mainstay of the structural laminating industry while others find special applications where their properties are desired. Occasionally, gluing characteristics and resistance to adverse use conditions may affect the choice of species, although tests have shown that glue joints of long-term durability and high strength can be produced with practically all domestic species. To attain this high joint strength and permanence, however, the gluing procedure must be adjusted more carefully and the adhesive must be of better quality for some species than for others.

Product quality or grade requirements are often established by design criteria or by use requirements. Defects permitted in spars or propellers, for example, are sharply limited. Severely curved parts of high-strength laminated members generally require clear and straight-grained wood, free of significant defects, so that the laminations may be bent to the desired curvature without breaking. Defects such as large holes, knots, and decay reduce effective glue-joint area. Surfaces containing pitch, cross grain, and knots do not glue so well as clear wood. Medium- to large-sized knots and knotholes aggravate glue-joint delamination when the exposure involves alternate wetting and drying. Lower grades of lumber, consequently, are less adapted to laminating timbers for exterior use than for interior use in which they are kept dry and undergo less severe changes in moisture content. If the members are well treated (after gluing) with an oil-borne preservative, lower grades might be used for exterior service if strength requirements are met.

Sapwood is as durable as heartwood under continuously dry conditions, but under moist service conditions the sapwood of even the durable species is susceptible to attack by wood-degrading fungi and by insects. When the laminated product must be durable under moist exposures, the wood should be treated with a suitable preservative.

Stresses in Laminated Members

Differences in shrinking or swelling are the fundamental causes of internal stresses. Within a single member, adjacent laminations should shrink and swell in about the same amounts and in the same direction. Laminations, therefore, should have somewhat similar shrinkage properties (table 2) and be at about the same moisture content when glued.

Maximum lengthwise shrinkage in a straight-grained piece of normal wood is only about one-third of 1 percent, but the shrinkage across the grain may be 10 to 30 times more. Cross grain as well as knots, burls, and other growth characteristics affect the strength of laminations. For this reason, slope of grain and knots are restricted in laminated timbers. In bending members, laminations with smaller knots and straighter slope of grain are usually placed in the outer laminations with the grade decreasing toward the center of the member.

If two or more pieces having different shrinkage values are glued together, even though they are straight grained, a moisture content change will cause them to shrink or swell in different amounts and thus set up stresses. Flat-grained or plain-sawed lumber shrinks or swells more in width with moisture changes than vertical-grained or quartersawed lumber. If internal stresses are to be avoided, therefore, flat-grained wood should not be glued to edge-grained wood. In softwood species for structural use, matching of

grain in adjacent laminations is much less critical than with dense high-shrinkage species. The top and bottom laminations on a laminated member are less apt to face check if the pith side is turned out because its shrinkage is less than the sap side (fig. 24). Where the laminations come from small trees, this might be a worthwhile practice to follow.

If adjacent laminations differ in moisture content at the time of gluing, stresses in the glue joint and irregularities in the surface will develop when the laminations later come to a common moisture content. The pieces should therefore be conditioned to about the same moisture content before being glued. For structural members, a range in moisture content no greater than 5 percent between laminations in a single assembly is suggested. If exact trueness of surface is important, as it may be in furniture, even this range may prove excessive. Stresses will also be created if the interior portion of any one board differs greatly in moisture content from the outer portion or shell, and it is suggested that such differences not exceed 5 percent.

Laminations up to about 2 inches thick are most commonly used in gluing straight timbers, provided that suitably dry stock is available. Within this 2-inch limit, the thickness of the lamination does not affect the performance or durability of well-glued joints, so that different thicknesses may safely be glued in the same laminated assembly. It may sometimes be desirable to use more than one thickness of stock in flat assemblies to attain maximum utility from the lumber supply or to fabricate a laminated member to close dimensions. For curved members, the maximum thickness of laminations is usually governed by the curvature to which the laminations are bent. The minimum radius to which dry, clear, straight-grained lumber can be bent without breaking is about 100 to 125 times its thickness and varies a great deal with the species of wood as well as within the same species. In general, hard-

woods can be bent more severely than softwoods of the same thickness.

Relief of Stresses

The stresses that develop in glued-laminated members due to differences in

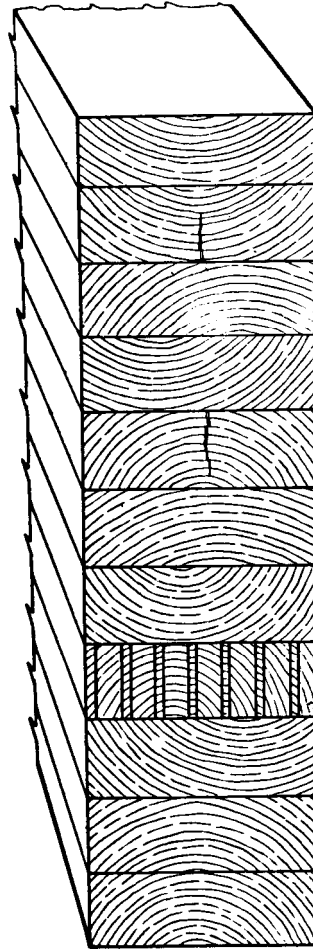

M 138 756

Figure 24.—End section of laminated beam having the pith side out in top and bottom laminations. Particularly in boards from small trees, the pith face has less checking tendencies than the sap face. (Fourth lamination from bottom shows section through vertical finger joint.)

the properties of the various laminations will gradually disappear if the glued article is kept for a long time at a constant moisture content. This is because of stress relaxation and creep characteristics of wood with time. Stresses due to moisture difference between laminations, or within laminations, at the time of gluing will not reappear after having once been relieved. Stresses due to cross grain or to differences in the shrinkage properties of the adjacent members, however, will reappear if the moisture content is changed after the stresses have once been relieved.

END AND CORNER JOINT CONSTRUCTION

When the end grain surfaces of two pieces of wood are glued together, a butt joint is formed. Mitered joints are usually cut at a 45° angle with the grain and must essentially be treated as butt joints for gluing purposes. If two pieces of plywood are glued edge to edge or if the edge of one piece of plywood is glued to the face or surface of another, only partially effective glue bonds are obtainable since edge grain of certain plies only is bonded to edge grain of plies of adjoining pieces. Several types of corner joints are shown in figure 25. The importance of moisture control where miter and other corner joints are involved is illustrated in figure 26. A somewhat different corner joint where moisture control and choice of low-shrinkage material is important is shown in figure 27.

No gluing technique has yet been devised to make square-end butt joints (fig. 25, *H*) sufficiently strong and permanent to meet the requirements of ordinary service, and no adhesive has been offered for commercial bonding of such joints.

Figure 28 compares bending strength (by two methods) of several types of glued corner joints made of particleboard. A miter joint with a plywood spline appears the most promising.

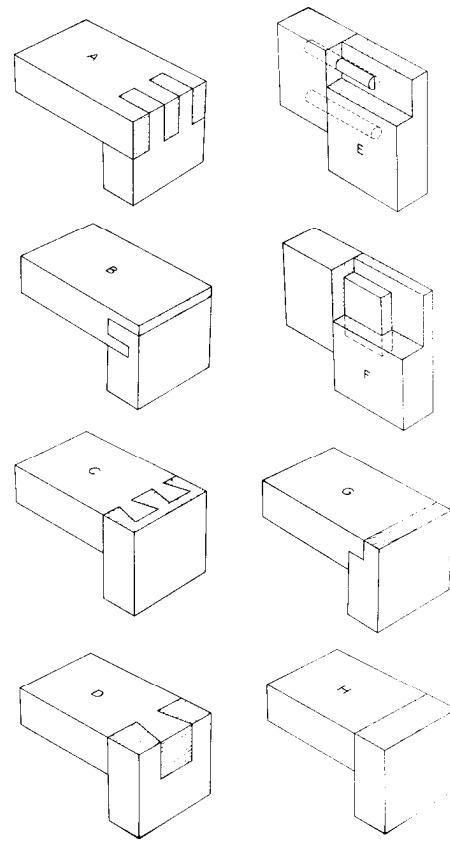

M 138 532

Figure 25.— Various types of corner joints: A, slip or lock corner; B, dado tongue and rabbet; C, blind dovetail; D, dovetail; E, dowel; F, mortise and tenon; G, shouldered corner; and H, butt end to side grain.

To obtain acceptable strength in pieces spliced together endwise, it is necessary to make a scarf, finger, or other sloped joint (fig. 29). The plain scarf with a low slope generally develops the highest strength, but is also the most wasteful of material and requires considerable care both in machining and gluing to obtain consistently high-quality joints. If the grain of a board to be spliced makes an angle with the face of the board, the scarf should be cut with the slope of the

EFFECT OF MOISTURE CONTENT
CHANGES ON MITER JOINT

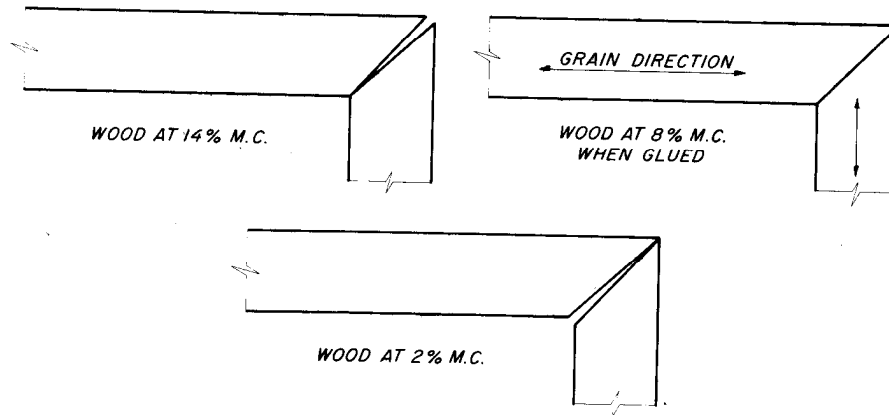

M 136 539

Figure 26.— Miter joints can open when high-shrinkage material is used and wide variations in moisture content occur. A glued spline or other reinforcement can reduce or prevent joint separation. Vertical-grained material, having lower shrinkage in width, will reduce chances for separation of this type of joint.

grain rather than against it to more nearly approach side grain on the scarfed surface. During the gluing operation, end slippage should be prevented to keep the parts in proper alignment, and a slight overlap is desirable to insure adequate pressure on the joint (fig. 30). If the members slip endwise during the pressing operation, the joint will not receive sufficient and uniform pressure and erratic strengths may be expected. Even plain scarf joints with a low slope are not as strong as clear wood (of the same quality) in tension parallel to the grain. Tests on specimens containing scarf joints stressed in tension indicated the average strength ratios given in this tabulation:

Slope of Scarf	Strength ratio (jointed/nonjointed) (Pct.)
1 in 12 and less steep	90
1 in 10	85
1 in 8	80
1 in 5	65

Adequate data are lacking on the durability of glued scarf joints with very steep

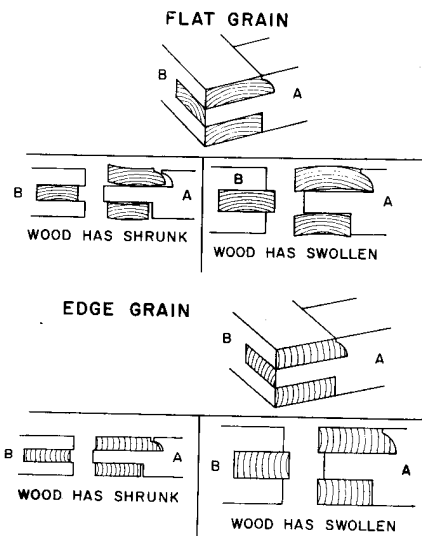

M 138 461

Figure 27.— Corner joint showing effect of serious moisture changes after fabrication (somewhat exaggerated to emphasize need for control of moisture content). The advantage of edge grain over flat grain in this type of construction is also evident.

TYPE OF JOINT	JOINT STRENGTH BASED ON BENDING STRENGTH OF PARTICLEBOARD (PCT.)	
	SPLITTING	SHANK LOADING
MITER GLUED	28	70
MITER WITH 3 DOWELS	38	73
MITER WITH PLASTIC ANGLE	22	75
BUTT WITH 3 DOWELS	36	47
MITER WITH PLYWOOD SPLINE	42	73

M 137 679

Figure 28.— Comparison of relative bending strength of different types of corner joints in particleboard. In addition to the mechanical reinforcement in four of the joints, they were also glued.

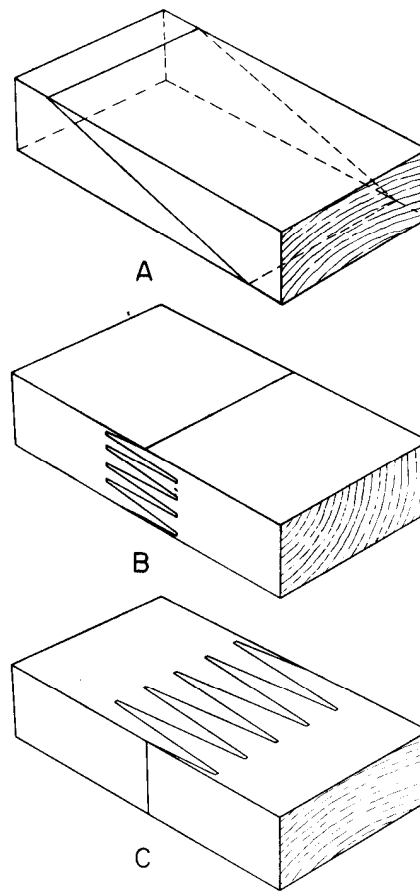

M 138 527

Figure 29.— End joints for splicing lumber (occasionally also used for panel products): A, scarf joint (when used with a low slope, can develop almost the full strength of wood); B, horizontal finger joint (cut parallel to wide face of board); C, vertical finger joint (cut perpendicular to wide face of board). Type C is the most commonly used finger joint for structural purposes.

slopes. If strength is important, therefore, it is probably advisable to avoid scarfs steeper than 1 in 10 for exterior use or other severe exposure.

Approximate tensile strengths (expressed as a percentage of clear wood) of various types of end joints are shown in figure 31.

Finger joints (fig. 29, B and C) lend themselves more readily to rapid production and uniform quality than do plain scarf joints and are more practical where their strength is sufficient for the design involved. Figure 32 illustrates a suggested method for applying pressure when gluing finger joints. When pressure is applied only in the longitudinal direction, unreliable bonds in the outer fingers may

result. With short fingers, this effect is not as pronounced as with long lingers.

Figure 33 shows a number of linger joints where the slope (angle between axis of member and sloping joint) and tip thickness (tip of linger) are held constant,

but the pitch (distance center-to-center of finger tips) increases from three-sixteenth inch to one-half inch and consequently the length also increases.

The tensile strengths of such joints, made with various slopes, are shown in figure 34. The sloping joint area (per square inch of section) is included for comparison. Reasonably good correlation between strength and joint area is indicated. This is logical because wood is roughly 10 times as strong in tension as in shear, and the number of strength-reducing finger tips decreases with increased joint area (fig. 33).

The joint geometry is as important as good glue and gluing practices to produce high-strength finger joints.

Finger-joint machining lends itself quite well to mechanized continuous operation. Figure 35 shows equipment that trims (or squares) the ends of boards

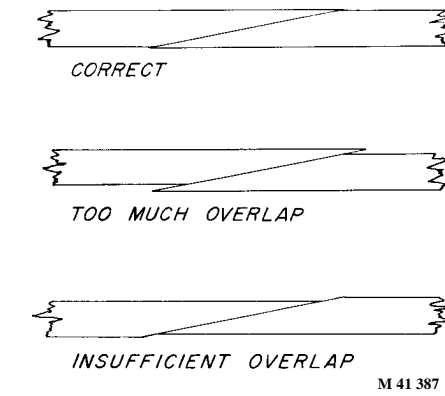
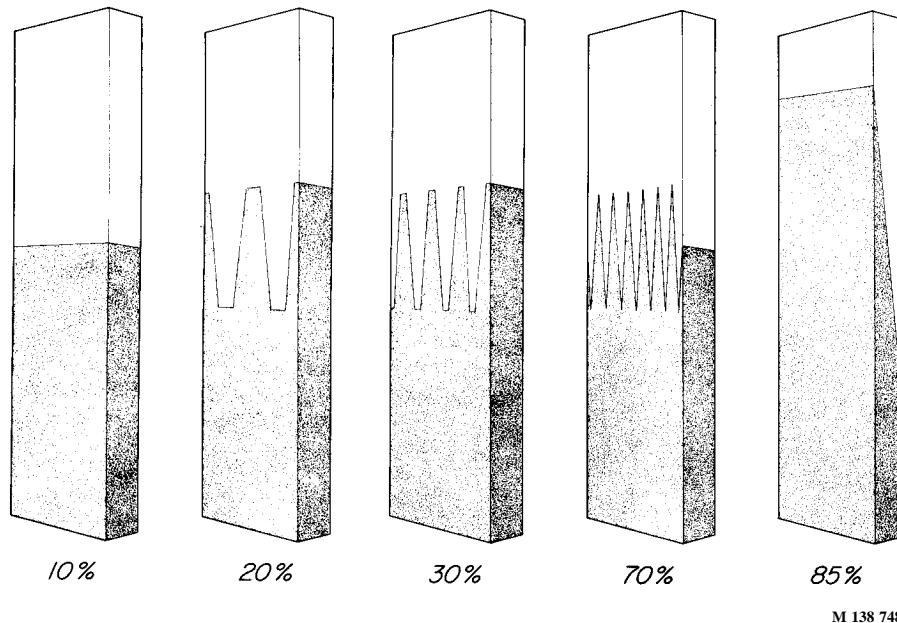

Figure 30.— Scarf joints should be properly aligned for gluing.

or planks, cuts the fingers, and applies glue to the fingers in rapid succession.

Where strength is important, joints such as the plain end to side grain (fig. 25, H) have proved entirely inadequate because



M 138 748

Figure 31.— Approximate percentage of the tensile strength of clear wood obtainable with different types of end joints. (Nearly the full tensile strength of a low-density species has been obtained with butt joints in laboratory experiments but no practical glue or gluing procedure have been developed to do this commercially.)

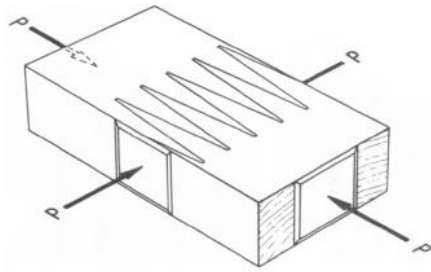

M 138 526

Figure 32.— Suggested method for applying pressure (P) to finger joints while glue is curing

they are commonly subjected to unusually severe stresses in service. Under changing moisture conditions, the end-grain surface of the joint tends to swell or shrink in all dimensions of the joint while the side-grain surface of the joint swells or shrinks only in one direction. Joints that are not subjected to much external stress may serve satisfactorily, for example joints made by gluing facing strips of veneer on the end edges of a crossbanded tabletop (fig. 19, B). In furniture parts, however, stresses might easily exceed the strength of end-to-side-grain joints in service. Ultimate failure of the joints usually results when external stresses are combined with

internal stresses from moisture changes. In the manufacture of such parts, it is therefore necessary to reinforce the end-to-side-grain joints with devices such as dowels and tenons (fig. 25, E and F). Even then, the stresses that recur with seasonal changes put a severe strain on the joints, which makes it very desirable to protect such joints against changes in moisture content. The strength and permanence of all types of end-to-side-grain joints depend upon the type of glue and gluing technique, the accuracy of the machining, and the design and fit of the parts.

In manufacturing wood assemblies, such as furniture, it is often necessary to fasten together two parts that shrink and swell differently with moisture changes. Tables and desks, for example, are usually designed so that the tops can be expected to swell or shrink differently than the frames. Even if feasible, it would be undesirable to glue the tops rigidly to the frames because the differences in shrinkage characteristics would tend to distort the tables. Chests are often designed so that the tops and bottoms can be expected to shrink or swell appreciably in width, while on the ends the wood grain runs lengthwise across the width and no significant change in this dimension can be expected. If the tops and bottoms of such items are

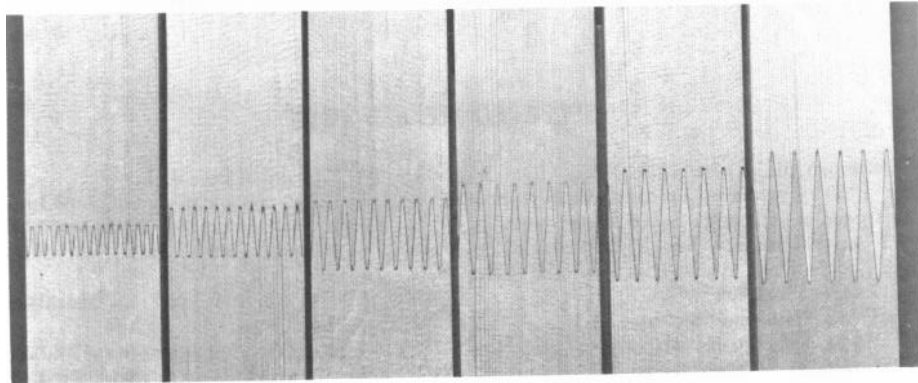

M 120 740

Figure 33.— Finger joints with constant slope (1:14, angle between axis of member and sloping joint) and tip thickness, but with increasing (from left to right) pitch and length of fingers.

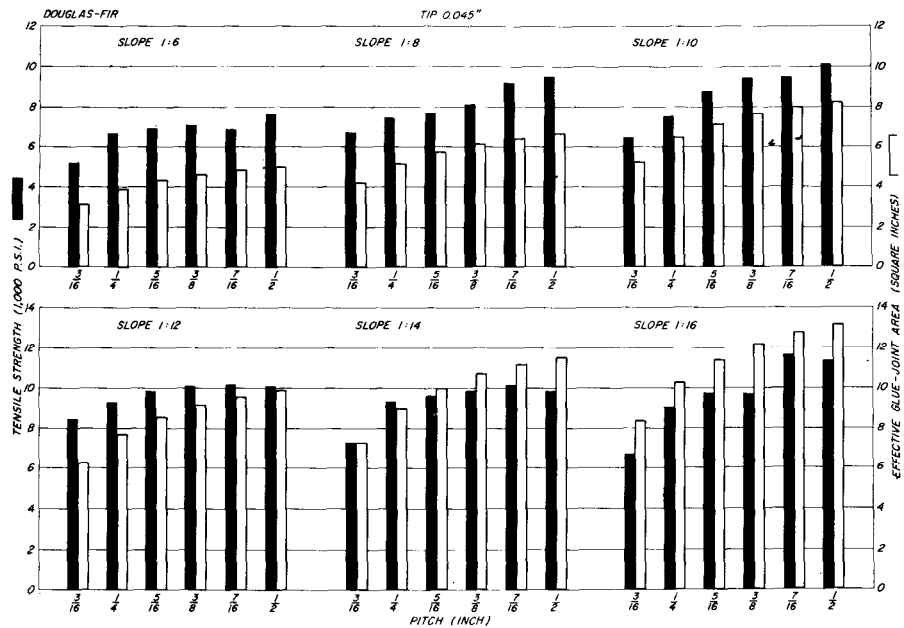

M 123 420

Figure 34.—Tensile strength of Douglas-fir finger joints with constant tip thickness and six different slopes. For each slope the pitch varied from three-sixteenth to one-half inch (see fig. 33).

glued or fastened rigidly to the ends, subsequent swelling or shrinking with moisture changes can be expected to cause splits and distortion, to break the joint, or to rupture the wood. In designing wood items, it is important to provide for de-

vices, such as slotted screw holes, that permit normal shrinking and swelling when two elements differing in shrinkage properties must be jointed together or to insure that all joining elements have similar shrinkage properties.

SELECTED REFERENCES

- Bohannon, Billy, and Selbo, M. L.
1965. Evaluation of commercially made joints in lumber by three test methods. U.S. For. Serv. Res. Pap. FPL 41, 41 p. U.S. Dept. Agric. For. Serv. For. Prod. Lab., Madison, Wis.
- Bryant, Ben S., and Stensrud, R. K.
1954. Some factors affecting the glue bond quality of hard-grained Douglas-fir plywood. For. Prod. J. 4(4):158-161.
- Cass, S. B., Jr.
1961. A comparison of hot-pressed interior plywood adhesives. For. Prod. J. 11(7): 285-287.
- Freas, A. D., and Selbo, M. L.
1954. Fabrication and design of laminated wood structural members. U.S. Dept. Agric., Tech. Bull. No. 1069. 220 p.
- Haskell, H. H., Bair, W. M., and Donaldson, William.
1966. Progress and problems in the southern pine plywood industry. For. Prod. J. 16(4): 19-24.
- Heebink, B. G.
1963. Importance of balanced construction in plastic-faced wood panels. U.S. For. Serv. Res. Note FPL-021. 5 p. U.S.

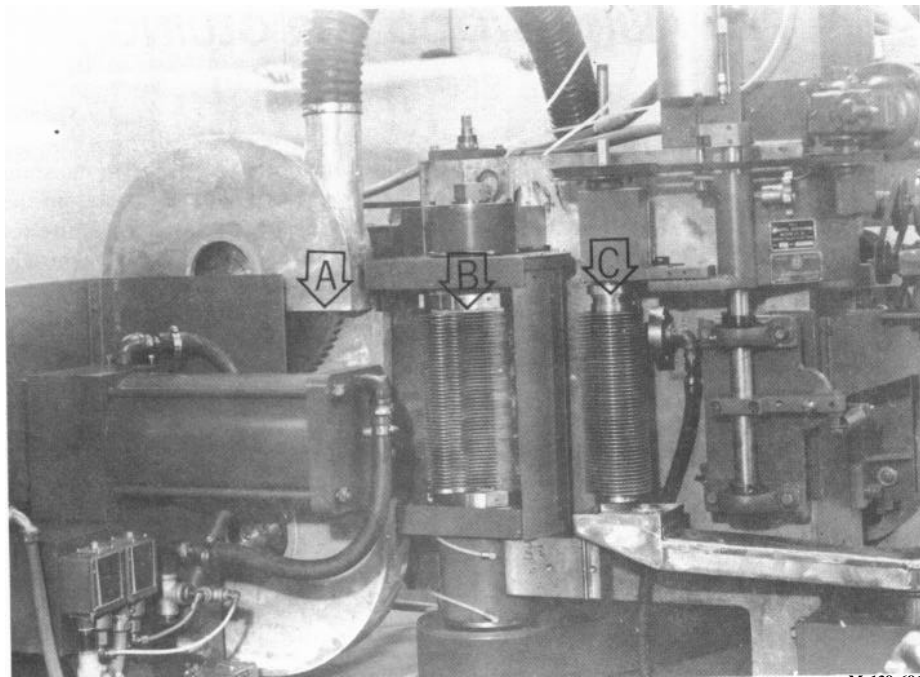

M 138 686

Figure 35.— Finger-jointing equipment: A, trim saw; B, cutter (or shaper) head; and C, glue applicator.

- Dept. Agric. For. Serv. For. Prod. Lab.,
Madison, Wis.
- Heyer, O. C., and Blomquist, R. F.
1964. Stressed-skin panel performance. U.S.
For. Serv. Res. Pap. FPL 18. 12 p. U.S.
Dept. Agric. For. Serv. For. Prod. Lab.,
Madison, Wis.
- Jarvi, R. A.
1968. Laboratory test for prepressing of ply-
wood. For. Prod. J. 18(3):53-54.
- Lambuth, A. L.
1961. Prepressing plywood assemblies. For.
Prod. J. 11(9):416-419.
- Raknes, E.
1967. Finger jointing with resorcinol glue at
high wood moisture content. Norwegian
Inst. of Woodworking and Wood Tech.
Rep. No. 32.
- Raknes, E.
1969. Finger jointing structural timbers
with a high moisture content. Norsk
Skogind 23(6):184-190.
- Roth, A.
1970. A new type of finger joint. Pap. ja
Puu 52(1):25-28.
- Selbo, M. L.
1963. The effect of joint geometry on tensile
strength of finger joints. For. Prod. J.
13(9):390-400.
- Stensrud, R. K., and Nelson, J. W.
1965. Importance of overlays to the forest
products industry. For. Prod. J. 15(5):
203-205.
- Strickler, M. D.
1970. End gluing of lumber. For. Prod. J.
20(9):47-51.
- Strickler, M. D., Pellerin, R.-F., and
Talbott, J. W.
1970. Experiments in proof loading struc-
tural and end-jointed lumber. For. Prod.
J. 20(2):29-35.
- U.S. Forest Products Laboratory, Forest Service
1966. Some causes of warping in plywood
and veneered products. U.S. For. Serv.
Res. Note FPL-0136. 8 p. U.S. Dept.
Agric. For. Serv. For. Prod. Lab., Madi-
son, Wis.
- U.S. Forest Products Laboratory, Forest Service
1974. Wood handbook: Wood as an engi-
neering material. U.S. Dept. Agric.,
Agric. Handb. 72 rev. 432 p.

PREPARING WOOD FOR GLUING

Glues vary in properties and use characteristics as well as in quality, but in most instances failure of glue joints can be traced to improper preparation of the wood. Among the various factors causing inadequate glue bonds, the most prevalent is lack of proper moisture control, both before and after gluing.

MOISTURE CONTENT

The moisture content of wood at the time of gluing is important because it affects the quality of the bond and the performance of the glued product in service.

Satisfactory adhesion to wood is obtained with most adhesives when the wood is at moisture contents of about 6 to 17 percent, and with some glues well beyond this range (up to 25 pct. has been reported for resorcinol adhesives). The precise upper and lower limits vary with adhesive type and formulation. Satisfactory joints have been made experimentally with wood that was near the fiber saturation point (with resorcinol-type glues) and at very low moisture contents (with casein glue).

The moisture content of the wood affects the rate of change of viscosity of many adhesives during the assembly period. It also affects the rate of setting and, in hot pressing, it affects markedly the tendency to form blisters (unbonded areas caused by formation of steam in the joint when moisture content is too high). Consequently, the moisture content of the wood may necessitate adjustments compatible with the gluing procedure.

Most importantly, moisture content of the wood at the time of gluing has much to do with the final strength of the joints, the development of checks in the wood, and the stability (freedom from warping)

of glued members. A change in moisture content generally develops stresses on the glue joints; the magnitude of these stresses is roughly proportional to the magnitude of the change with a particular species. A certain percentage change in a dense wood develops greater stresses than the same change in a light species.

Glue joints will remain most nearly free from stresses if the moisture content of the glued parts (when the glue sets) equals the average moisture content the product will attain in service. The moisture content of wood for gluing, when increased by the water from the glue, should be as near as possible to the average moisture content that the glued member will have in service.

The moisture content of dry wood in service above grade in dwellings in the United States commonly varies from about 4 percent to about 13 percent. The wood in a chair in a dwelling in northern Minnesota, for example, may have a moisture content as low as 4 percent in the winter and as high as 10 percent in the same room in the summer. Wood in a similar item in a dwelling along the Gulf Coast may maintain a moisture content varying little from 13 percent throughout the year. Except for the coastal areas and certain arid inland areas, the moisture content of wood in heated buildings will average about 7 or 8 percent for the year. Dry wood in protected but unheated shelters has an average of about 12 percent moisture throughout a large part of the United States, but the average is less in the arid areas and more along the coasts.

The amount of water added to the wood in gluing varies from less than 1 percent in lumber 1 inch thick to over 60 percent in thin plywood where the amount of wood is small in proportion to the amount of glue. Calculated percentages of moisture

added to wood in gluing are given in table 3 for a number of species in constructions. Thickness of the wood, number of plies, density of the wood, glue mixture, and quantity of glue spread all affect the increase in the moisture content of the wood when the glue is spread. If pertinent tables are not readily available, the percentage of water added with the glue may be calculated from the following formula:²

$$P = \frac{0.000192WG}{TS} \frac{L - 1}{L}$$

²Both this formula and the percentages listed in table 3 are based on the assumption that all wafer added by the glue is absorbed by the wood. The assumption is somewhat erroneous, but the method yields results sufficiently accurate to guide in selecting suitable moisture contents.

- where P = percentage of water added
w = pounds of water in 100 pounds of mixed glue
G = pounds of mixed glue used per thousand square feet of glue-joint area
L = number of laminations
L - 1 = number of gluelines in glued assembly
T = average lamination thickness (in inches)
S = specific gravity of wood (dry)

Thin veneer, even if dried almost free of moisture, will take up so much water from wet glue that its moisture content will become higher than the probable average for the plywood in service. Very dry veneer is easily split or cracked and is difficult to handle before and during the

Table 3. ---Calculated percentages of moisture¹ added to wood in gluing (five-ply construction)

Adhesive	Glue spread ²	Lamination or ply thickness	Wood species				
			Hard maple	White oak	Mahogany	Douglas-fir	Southern pine
		<i>Inch</i>	<i>Pct.</i>	<i>Pct.</i>	<i>Pct.</i>	<i>Pct.</i>	<i>Pct.</i>
Casein	65	3/4	1.4	1.3	1.8	1.9	1.8
Do.....	95	3/4	2.1	2.0	2.7	2.7	2.6
Do.....	65	3/8	2.8	2.7	3.6	3.7	3.5
Do.....	95	3/8	4.2	3.9	5.3	5.5	5.1
Urea resin	45	3/4	.6	.6	.8	.8	.7
Do.....	65	3/4	.9	.8	1.1	1.1	1.0
Do.....	45	3/8	1.2	1.1	1.5	1.5	1.4
Do.....	65	3/8	1.7	1.6	2.2	2.2	2.1
Resorcinol or intermediate-temperature-setting phenol	45	3/4	.4	.4	.6	.6	.5
Do.....	65	3/4	.6	.6	.8	.8	.8
Do.....	45	3/8	.9	.8	1.1	1.2	1.1
Do.....	65	3/8	1.3	1.2	1.6	1.7	1.6

¹Moisture calculated on the basis of average specific gravity values as follows: Hard maple, 0.63; white oak, 0.67; mahogany, 0.49; Douglas-fir, 0.48; southern pine, 0.51. Glue mixtures used were:

Casein, 1 part solids to 2 parts wafer; urea resin, 1 Part solids to 0.65 part water; resorcinol and intermediate-temperature-setting phenol, 70 pct. solids.

²In pounds per square foot of joint area.

gluing operation. It also very quickly reabsorbs moisture during handling. Therefore, it is not practical to dry it below 2 or 3 percent moisture content. Furthermore, experience has shown that a moisture content of 5 percent or less in the veneer at the time of gluing is satisfactory for furniture and similar uses.

Lumber with a moisture content of 6 to 8 percent is satisfactory for gluing into furniture and similar items that will be used in most of the areas of the continental United States. Lumber for use in unheated buildings or shelters, and in partially protected installations, should generally contain about 11 percent moisture before gluing. The moisture added in gluing will then bring the total moisture to about 12 percent. In moist, wet, or unprotected exterior exposures, glued members may develop moisture contents well above 12 percent. A moisture content range of 12 to 15 percent, however, is generally satisfactory for such gluing.

The manufacturer shipping glued articles to various parts of the country and making products for various uses cannot provide for all the variations to be met in service. He must, therefore, aim at approximate averages. Wherever feasible, a finish that effectively excludes moisture will guard against checking and joint failure because it slows down the rate of moisture changes.

DRYING AND CONDITIONING

Wood free from casehardening and other internal stresses will be best for gluing. Internal stresses, which generally result from drying, may prevent a good fit of the mating surfaces and mean warping and checking after the wood is glued. Dried wood should be tested for the presence of such stresses before it is removed from the kiln. If wood is casehardened or otherwise stressed, it should be treated to relieve the stresses.

Lumber

In drying lumber, although the desired average moisture content may be reached, individual differences may be considerable; variations can occur in the moisture content of individual boards and even between different parts of the same board. It is desirable to reduce these differences as much as possible before gluing. In laminating nominal 1-inch boards, for example, moisture content should vary no more than 5 percent between members in a single assembly or between different parts of the same board.

To obtain such uniformity, a conditioning period after kiln or air drying is usually desirable. Conditioning is best accomplished in a storage room in which the temperature and humidity are controlled to maintain the desired moisture content. The time required for conditioning depends upon the species, dryness, method of piling, and circulation of air, as well as upon the temperature and relative humidity of the storage room. A conditioning period of 1 week in open piling is beneficial. Dense species generally require longer conditioning than lighter ones and the moisture content equalizes more rapidly with increased temperatures.

Veneer

Veneer is generally dried in mechanical dryers of various types, but may occasionally be kiln or air dried. The internal stresses that develop in drying veneer are generally not as great a problem as with heavier stock. Occasionally, however, internal stresses do cause wrinkling, checking, or honeycombing of the veneer. These defects are easily recognizable and usually can be avoided by improving the drying conditions.

In plywood plants where veneer is cut, it is customary to glue it soon after drying. For general purposes, veneer is in condition for gluing if it is reasonably flat, tightly and smoothly cut, free from defects not

permitted by the grade, and at a moisture content suitable for the glue and gluing process. For most cold-press gluing, the moisture content of veneers should be 5 percent or less. For hot pressing (with liquid glues), thin veneers should be 5 percent or less in moisture content; moisture content of thicker veneer may be slightly higher, depending upon the species, the amount of glue spread, and the temperature of the press platens. If the moisture content is too high, steam blisters will form when the pressure is released. Veneer may take on moisture in lengthy shipment or storage, and it is good practice to redry it just before gluing. Fine hardwoods are often redried in hot plate dryers in which the veneer remains between the plates until it is sufficiently dry and flat. In the best practice, the veneer is then piled so that it will stay flat and will cool before gluing, but so it will not reabsorb much moisture from the air.

Fancy veneer, such as burl, crotch, or other short-grained pieces, is more likely to wrinkle and check than straight-grained veneer. Film glue is well suited for fancy veneers and they may be hot pressed with the veneers at a moisture content of 8 to 10 percent. Fragile figured veneers are sometimes toughened by dipping them in a liquid sizing solution and then redrying. Several different sizing solutions have been used, but one satisfactory solution is:

<i>Ingredient</i>	<i>Parts by weight</i>
Water	63
Animal glue	16
Alcohol	16
Glycerine	5

It is often desirable to reinforce highly figured veneer to reduce dimensional changes and facilitate handling. This is sometimes done by bonding the figured face veneers to a thin but strong veneer backing (as 1/40-in. birch or maple) using a film glue. Film glue adds no moisture to the veneer and permits forming the bond when the moisture content of the face

veneer is about 8 percent, so that chance of subsequent drying and checking is reduced or eliminated.

Wet veneer is likewise glued to paper facings to form a paper-veneer combination for containers.

STORAGE BEFORE GLUING

It is not sufficient only to dry and condition wood to the proper moisture content for gluing. Because a storage period is generally required between drying and final machining and gluing, provisions must be made to prevent appreciable moisture changes during this time.

Lumber

The ideal condition is to provide storage space for dried lumber with humidity and temperature control to maintain the moisture content in the stock at a level suitable for gluing—such as 7 percent for most indoor use and about 12 percent for outdoor service. If the temperature is controlled at about 75° F. and the relative humidity at 35 percent (wet-bulb depression about 16° to 17° F.), the moisture content of the wood will be suitable for interior woodwork.

If controlled temperature and humidity storage is not possible, maintaining the temperature in the storage room about 20° F. above the outdoor temperature will provide a moisture content in the lumber of 6 to 8 percent in most parts of the United States. Similarly, if the lumber is stored under roof in an unheated area, the moisture content will be fairly close to 12 percent when the lumber is stored for a sufficient time to come to equilibrium. It is very important, however, that during cold weather the lumber be brought into a warm room at least 24 hours before machining and gluing; cold lumber will slow down the rate of cure and generally result in inferior glue bonds. This is important when using resin adhesives, but even a

protein-base glue such as casein has given more dependable results on lumber warmed to room temperature before gluing.

Warming lumber of the denser species before gluing is especially important.

Veneer

Veneer is usually glued shortly after drying to minimize the chance for appreciable moisture changes. Gluing hot veneer, however, must be avoided to prevent the glue from becoming too dry before pressure is applied.

When 2 to 3 days lapse between drying and gluing, provision must be made to prevent moisture changes. Even though the veneer is solid stacked, the ends and the top of the loads may gain moisture rapidly. If it is impossible to store veneer at the proper equilibrium moisture condition (less than 5 pct. when hot pressing with liquid phenolics), covering the loads completely with moistureproof film (polyethylene) provides considerable protection.

SURFACING WOOD FOR GLUING

Careful machining is essential in preparing wood for gluing. For strongest joints, wood surfaces should be machined smooth and true with sharp tools, and be essentially free from machine marks, chipped or loosened grain, and other surface irregularities. To provide uniform distribution of gluing pressure, each lamination or ply should be of uniform thickness. A small variation in thickness among laminations or plies may cause considerable variation in the thickness of the assembly. In the production of glued-laminated members, for example, the differences in thickness throughout a lamination consisting of a single board should not exceed 0.016 inch. When the lamination consists of two or more boards, laid side by side or end to end, differences in thickness at the edge and end joints between any two boards

in the layer should not exceed 0.010 inch. Experience has indicated that cup in inches in boards after final surfacing preferably should not exceed one ninety-sixth of the ratio of width to thickness. Thus, for laminations 6 inches wide, a maximum cup is suggested as one-sixteenth inch in a board 1 inch thick, one-eighth inch in a 1/2-inch board, and one-fourth inch in a 1/4-inch board.

Preferably, machining should be done just before gluing so that the surfaces are kept clean and are not distorted by moisture changes. Where the four sides of a piece are to be glued, it is best to glue in two operations and machine just before each operation.

Surfaces made by saws are usually rougher than those made by planers, jointers, and other machines equipped with cutter heads. Modern saws freshly sharpened, well aligned, and skillfully operated are capable of producing surfaces adequate for gluing many products and provide a saving in time and labor. Except where the saws are usually well maintained, however, glue joints between sawed surfaces are weaker and more conspicuous than those between well-planed or jointed surfaces. Consequently, if inconspicuous glue joints of maximum strength are required, planed or jointed surfaces are generally more reliable.

Machine marks, caused by feeding the stock through a planer too fast for the speed of the knife, prevent complete contact of the joint faces when glued. Machine marks in cores of thinly veneered panels are likely to show through the finished surface. Unequal thickness or width, which cause unequal distribution of gluing pressure and usually result in weak joints, may be due to the grinding, setting or wearing of machine knives. Knives that are dull or improperly set or ground may produce a burnished surface that interferes with gluing or formation of the strongest glue bonds.

Wood surfaces are sometimes intentionally roughened by tooth planing,

scratching, or sanding with coarse sandpaper in the belief that rough surfaces are better for gluing. However, comparative strength tests at the Forest Products Laboratory failed to show better results with roughened than with smooth surfaces. Also, studies of the penetration of glue into wood have shown the theoretical benefit of the roughened surface to be improbable. Light sanding has proved an advantage in preparing for gluing such surfaces as resin-impregnated wood, laminated paper plastic, plywood that has been pressed at high temperatures and pressures, or wood that has been glazed from dull tools or by being pressed excessively against smooth, hard surfaces.

Within recent years, significant developments in sanding equipment have been reported. Advantages of so-called abrasive planing in preparing wood for gluing are reported to be deeper cuts in a single pass, close tolerances, and improved surface quality for gluing.

MACHINING SPECIAL TYPES OF JOINTS

Plain side-grain-to-side-grain joints are generally prepared with planers and jointers equipped with rotary cutter heads and knives. With such equipment, clean-cut smooth surfaces for gluing are relatively easy to obtain when the machines are well maintained. With special or irregularly shaped joints, ideal surfaces for gluing are often more difficult to obtain.

Side-Grain Surfaces

Plain, tongue-and-groove, circular tongue-and-groove, and dovetail are four of the more common types of edge joints used in gluing boards into wider pieces (fig. 36). As knowledge of adhesives and gluing techniques has increased, the plain edge joint has become far more common than any of the others. With most species of wood, straight plain joints between side-

grained surfaces can be made substantially as strong as the wood itself in shear parallel to the grain, tension across the grain, and cleavage. The tongue-and-groove and other shaped joints have the theoretical advantage of larger gluing surfaces than the plain joint, but the extra surface is not needed because adequate plain joints can be produced easily by normal commercial gluing procedures. Furthermore, the

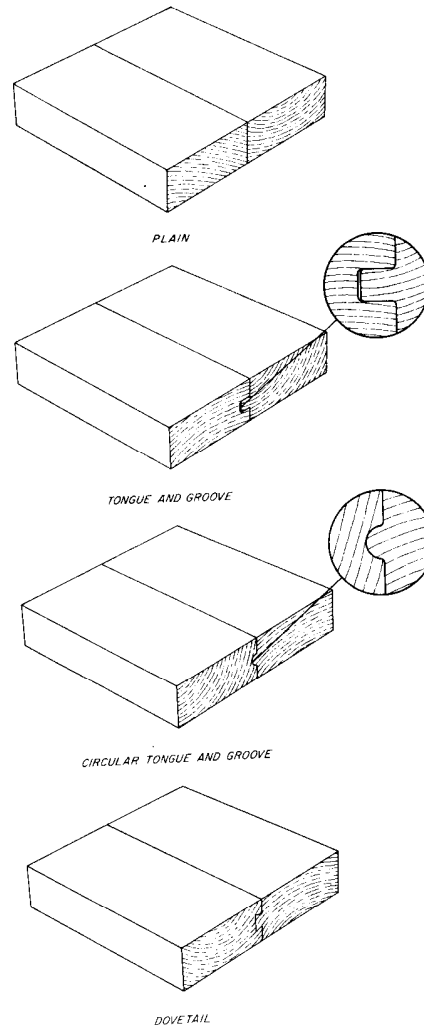

M 138 531

Figure 36.— Various types of edge joints. The plain (top) is the most commonly used.

theoretical advantage is often lost, wholly or in part, because the shaped joints are more difficult to machine to a perfect fit than are plain joints.

Experience has shown that the lack of a perfect fit in tongue-and-groove or dovetail construction often results in joints that are weaker than plain joints. The principal advantage of the tongue-and-groove joint is that the pieces of wood to be glued are more easily aligned and held in place during assembling. This makes possible faster clamping and less slipping of the parts under pressure, which are advantages so important that some form of tongue and groove is often used in edge gluing where pressure is applied by clamps. A shallow tongue and groove (one-eighth inch or less) is as useful in this respect as a deeper cut and is less wasteful of lumber.

End-Grain Surfaces

It has proved practically impossible to make end-grain butt joints sufficiently strong or permanent for ordinary service. With certain synthetic resins (epoxies and urethanes) it has been possible to approach the tensile strength of weaker species, but such end gluing is of little practical value because of low bending strength and cumbersome gluing procedures. To approach the tensile strength of various species by end jointing, use a plain scarf, finger joint, or other form of joint that exposes a certain amount of side-grain surface (fig. 29). A serrated scarf appears advantageous in providing greater gluing area than a plain scarf, but has never been extensively used because of greater difficulties in machining it. Even the plain scarf has essentially been replaced by finger joints, except in cases where maximum strength is needed.

Careful machining to insure an accurate fit of the surfaces is essential to develop the maximum potential strength of the joint. With available glues the plain scarf with a low slope generally will produce the highest strength. Even with very low slopes the average strength of scarf joints,

well-machined and well-glued, is less than the average strength of solid wood in tension. Presumably strength is lower because of the difficulty inaccurately aligning the structural wood elements of one piece with those of the joining piece and because of stress risers at the tip of the scarfs.

End-to-Side Surfaces

End-to-side-grain joints are difficult to machine properly and to glue adequately for ordinary requirements. Such joints are subjected in service to unusually severe stresses as a result of unequal dimensional changes in the two members of the joint as the moisture content changes. It is therefore necessary to use dowels, tenons, or other devices to reinforce the joint by bringing side grain into contact with side grain (fig. 25, E and F). In dowel, mortise-and-tenon, dado, tongue-and-groove, rabbet, slip, and dovetail construction, an imperfect fit of the parts often results in only partial adhesion in the joints. In most of these joints, complete contact over poorly fitted portions cannot be obtained by ordinary gluing. Furthermore, pressure is often applied but momentarily in gluing and the glue does not set during the pressure period. Careful machining of irregularly shaped joints is therefore highly important to obtain maximum strength and durability in service.

CUTTING AND PREPARING VENEER

Veneer is commonly rotary cut, sliced, or sawn. The total quantity of rotary-cut veneer, however is much larger than the combined amount of sawed and sliced veneer produced. Most rotary-cut veneer is produced in large sheets by revolving the log against a knife. The flat-grained veneer produced in this manner is peeled off in a continuous sheet very much like unrolling paper. The half-round and back-cutting processes produce highly figured veneer

from stumps, burls, and other irregular parts of logs. These processes consist of placing a part of a log or bolt off center in a lathe, usually with an auxiliary device called a staylog, and rotary cutting the bolt into small sheets of veneer. As the veneer is bent away from the log during cutting, the open (knife) side often develops checks. This open side is likely to show defects in finishing and should be the glue side whenever possible.

Rotary-cut veneer is produced in thicknesses ranging from about five-sixteenths to one one-hundredth of an inch.

Sliced veneer is cut to obtain a definite figure and is produced in long, narrow sheets by moving a flitch or block against a heavy knife. The veneer is forced abruptly away from the flitch by the knife, thus causing fine checks or breaks on the knife side. The checked or open side should be the glue side whenever possible.

In book-matching face stock where the open side of every other sheet must be the finish side, the veneer must be well cut. Mahogany, walnut, and other prized hardwoods are commonly sliced for the furniture trade, and slicing softwood for vertical grain stock is becoming common practice. Most sliced veneer is cut in thicknesses ranging from about one-sixteenth to one one-hundred twenty-fifth or an inch, but for special orders veneer one-eighth inch or thicker can be cut.

Veneer is also sawed from flitches, usually to get a desirable figure or grain. It is produced in long, narrow strips which are essentially of the same 'quality and appearance on both sides. Being equally firm and strong on both sides, alternate pieces may be turned over to match them for figure to serve as the faces of veneered panels. Sawed veneer usually ranges in thickness from one-fourth to one-thirtieth of an inch. Because sawing wastes material, many mills have discontinued production of sawed veneer.

Sliced and sawed veneers are used principally for faces in plywood and veneered panels. Rotary-cut veneer is used for face

stock, thin cores (five-sixteenth inch and less), for cross-banding, and for curved laminated members. Most veneer that is glued ranges in thickness from one-fourth to one thirty-second inch. Veneer thinner than about one thirty-second inch is difficult to bond with liquid glues because the sheets are fragile and curl readily when the glue is spread. Thin veneers can be glued without prohibitive difficulty, however, with film glues.

Veneer surfaces, particularly the loose sides, are often somewhat rough and irregular, but by heating the logs and careful cutting, veneer can be produced that is comparatively smooth and firm on both sides. Since veneer is seldom resurfaced before it is glued, the care with which it is cut is important to good gluing. If it is equally well cut, veneer produced by any of the three processes can be glued equally well.

In gluing operations where mull-sized sheets of veneer are available, the sheets may be glued immediately after drying. Cutting to size is preferably done before the final drying. Cutting after drying allows more opportunity for the veneer to reabsorb moisture from the air. Further, very dry veneer is easily damaged and should be handled as little as possible.

Whenever a face for a high-grade veneered panel is made of two or more sheets of veneer, careful edge jointing is necessary to make the joints inconspicuous. This type of joint is made by placing the dried veneer in piles of several sheets and then running the piles over a special veneer jointer which makes the individual veneer edges smooth and true. These sheets are then laid in the desired position and either glued together in a special machine called a tapeless veneer splicer or taped tightly together by taping machines. In recent years, the taping process has been increasingly replaced by a machine that glues a thread (usually glass fiber) in a zig-zag fashion across the veneer joint (fig. 37). The glue is a hot melt, permitting very rapid edge bonding of veneers.

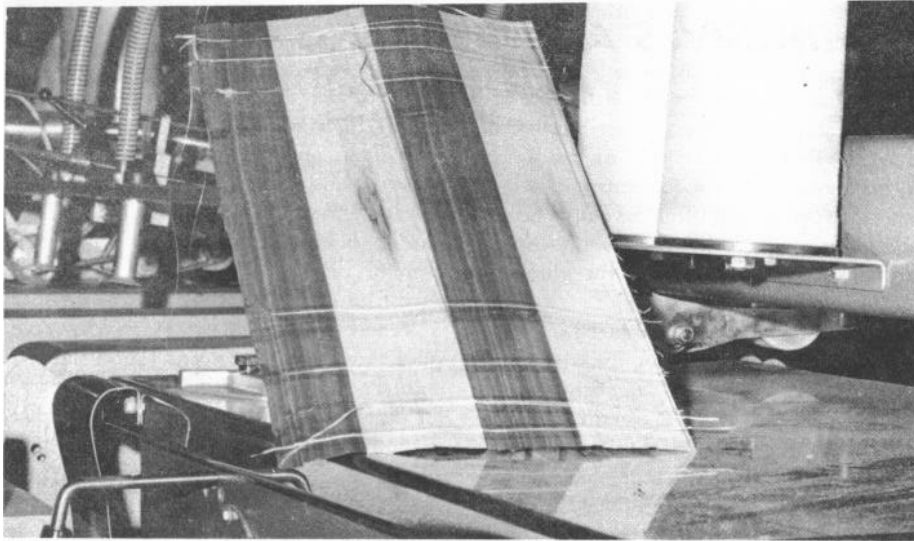

M 138 265-11

Figure 37.— Machine for edge-bonding veneers by gluing hot-melt saturated threads across the faces of adjacent strips. A zig-zag thread pattern is used when tighter edge bonding is required.

For cores, crossbands, and sometimes even for faces, perfectly tight joints between the edges of the veneer are not necessary. Such items may be jointed satisfactorily on a veneer clipper. For general utility plywood, where thick veneers are used, the veneer sheets are merely laid in position without fastening of any kind. The spaces between the sheets or even lapped edges, which often result, are of minor importance in this grade of panels.

If a very high-quality finish or a very high degree of resistance to severe service is desired, edge gluing of all veneer joints is justified. If the tapeless splicer is used for this purpose, the amount of glue spread must be carefully controlled lest excess glue squeeze out on the surface of veneer and interfere with subsequent gluing. Excessively high pressures or temperatures of the shoe of the tapeless splicer may burnish the edges of the veneer sheets enough to cause a weakly bonded streak in the plywood. If weather resistance is important, the adhesive used to splice the sheets should be as durable as the adhesive used in bonding the plywood.

SELECTED REFERENCES

- Davis, E. M.
1962. Machining and related characteristics of United States hardwoods. U.S. Dep. Agric., Tech. Bull. No. 1267. 68 p.
- McMillen, J. M.
1963. Stresses in wood during drying. U.S. For. Prod. Lab. Rep. 1652. 33 p. U.S. Dep. Agric. For. Serv. For. Prod. Lab., Madison, Wis.
- Peck, E.C.
1932. Moisture content of wood in dwellings. U.S. Dep. Agric. Circ. 239. 24 p.
- Rasmussen, E. F.
1961. Dry kiln operator's manual. U.S. Dep. Agric., Agric. Handb. No. 188. 197 p. Mar.
- Rietz, R. C., and Page, R. H.
1971. Air drying of lumber: A guide to industry practices. U.S. Dep. Agric., Agric. Handb. 402. 110 p.
- Simpson, W. T., and Soper, V. C.
1970. Tensile stress-strain behavior of flexibilized epoxy adhesive films. USDA For. Serv. Res. Pap. FPL 126. 13 p. U.S. Dep. Agric. For. Serv. For. Prod. Lab., Madison, Wis.
- Sisterhenm, G. H.
1961. Evaluation of an oil-fired veneer dryer-its effect on glue bond quality. For. Prod. J. 11(5):207-210.

ADHESIVES AND BONDING PROCESSES FOR VARIOUS PRODUCTS

As indicated earlier, adhesives that are excellent for bonding certain wood species may not be equally well suited for others. In a similar manner, and particularly because production procedures vary, an adhesive well suited for one product may be entirely impractical for another. As an example, alkaline phenolics have for years been the mainstay in production of exterior-type softwood plywood, but their high-temperature-curing requirements keep them from being practical for laminated timbers. Such timbers would explode from steam formation in the interior if heated to the temperatures required to cure phenolic-type adhesives used for plywood.

No detailed discussion will be attempted on the manufacture and composition of different types of adhesives. The user is more concerned with how well the adhesive adapts to his process and the dependability of his products. Hence, good communication between supplier and user is more important than knowledge of the type of hardener, filler, extender, solvent, and fortifier that may or may not be employed in formulating the adhesive.

A brief discussion of adhesives and production procedures for major segments of the wood gluing industry follows.

PLY WOOD

Softwood plywood is generally produced in two types, interior and exterior. Exterior plywood is bonded with completely waterproof adhesive that must be able to withstand temperatures that chat the wood without separating joints. Interior plywood is produced with three levels of glue-bond quality: (1) Interior or moisture resistant, (2) intermediate moisture resist-

ant (lower than exterior but greater than interior), and (3) exterior adhesive, with veneers that may be of lower grade than required for exterior plywood.

Minimum requirements for each type, developed through correlation with results of long-term exposures, are detailed in Product Standard PS1.

High-temperature-setting (alkaline) phenol resin adhesives are used almost exclusively for exterior softwood plywood. Formulations vary and what is suitable for one species may not necessarily be the ideal adhesive for other species. Adhesives that had been used successfully for years in production of Douglas-fir plywood did not give the same troublefree performance on southern pine, and reformulation of phenolic adhesives for southern pine became necessary. Higher glue spreads were generally required for southern pine plywood than for Douglas-fir plywood.

For moisture-resistant glue bonds in interior plywood, soybean glues, generally fortified with some blood, or highly extended phenol resin glues are usually employed. For intermediate moisture-resistant interior plywood, extended phenol resin adhesives or blood glues fortified with phenol resin are commonly used.

Both exterior and interior plywood glue bonds are cured in multiopening hot presses; steam is employed to raise the press platens to the required temperature. Interior plywood is sometimes also made by cold pressing. The glue is then usually mixtures of soy flour and spray-dried blood, often of low solubility, or even straight blood. There is still some straight soy flour glue used, but the quantity is quite small. Figures 38 to 43 illustrate the major steps customarily employed in softwood plywood production. Within recent years more automated layup systems



M 138 193

Figure 38.— Rotary cutting of Douglas-fir veneer.



M 138 190

Figure 41.— Spreading glue on veneer with a conventional double-roll glue spreader and assembling the veneers for plywood.



M 138 192

Figure 39.— Clipping softwood veneer to width and cutting out objectionable defects.



M 138 352

Figure 42.— Equipment for applying adhesive to veneer by curtain coating. A, Veneer sheet entering coater; B, veneer sheet coated with adhesive going to layup table.



M 138 197

Figure 40.— Drying softwood veneer in roller-conveyor dryer.



M 138 191

Figure 43.— Glued and assembled veneers being transferred to automatic press loader. Arrow points to 20-opening steam-heated hot press.

have been explored where the core pieces are joined edge to edge with hot-melt-coated threads (fig. 37) and then cut to panel size. Glue is applied by rubber-covered roll spreader (fig. 41), spray systems, or by curtain coating (fig. 42). Curtain coating is reported to result in more uniform spread as well as less waste of adhesive.

While softwood plywood finds its major uses in structural applications such as housing, most hardwood plywood is produced for furniture, wall paneling, door skins, and similar uses. Hardwood plywood is also classified according to glue-bond quality: Type I and technical, fully waterproof; type II, water resistant and type III, moisture resistant.

Adhesives used for type I and technical are generally phenol resin, melamine, or melamine-urea combinations. This does not imply that these two adhesive types are considered equally resistant or durable in long-term exterior service. Type II is bonded with urea resin (sometimes moderately extended), as well as other bonding agents of moderate moisture resistance. Type III is generally bonded with highly extended urea, but occasionally with casein glue.

Hardwood plywood is produced either by hot pressing or cold pressing, depending on the equipment available. Type I and technical, because of the adhesives employed, are hot pressed. Types II and III may be either hot or cold pressed depending on the adhesive used (ureas are formulated both for hot and cold pressing; casein is generally cold pressed).

Much hardwood plywood, particularly that going into furniture, is made with a thick core of lumber or particleboard, and occasionally other material. A common construction is made up of a nominal 1-inch core, crossbands of veneer frequently one-twentieth inch thick, and veneer faces one twenty-fourth or one twenty-eighth inch thick. Lumber core is often made up of narrow strips edge glued to the required width and with the annual rings perpendi-

cular to the face (fig. 19); this will reduce or eliminate cupping tendencies that are more apt to occur with wide, flat-grained core boards.

With particleboard cores (fig. 17), the crossbands are sometimes eliminated, depending upon various factors such as shape of particles, size of the panel, and shrinking and swelling characteristics both of the core and the veneer. For large panels such as tabletops, crossbands are usually employed; for smaller panels, and particularly if both the particleboard and the face veneers are from woods of low or moderate shrinkage, crossbands are often eliminated. Fine particles on the core faces are important when only face veneer is employed. Large particles are more likely to cause showthrough. On the other hand, boards made of thin flakes generally shrink and swell less in width and length than boards made of particles such as slivers, shavings, or sawdust.

Materials for lumber-core panels are generally selected to obtain stable, smooth material that will not contribute to the warping of the panel nor contain defects that might show through the faces. Woods with a relatively low density, low shrinkage characteristics, uniform texture, and a reputation for staying flat in service are preferred.

Correct and uniform moisture content in the core at the time of gluing is also important. About 7 percent is suitable for most of the United States.

A simple method of determining changes in moisture content that might have occurred in the core after the panel was glued is illustrated in figure 44. A strip is cut from the panel in the direction of the grain of the crossbands, and with a thin bandsaw the crossbands are released from the core for a distance of about 10 inches. In figure 44, A, the core was in tension across the grain before releasing the crossbands, and had been at higher moisture content when the panel was glued. In figure 44, B, the core had been in compression before being released from the cross-

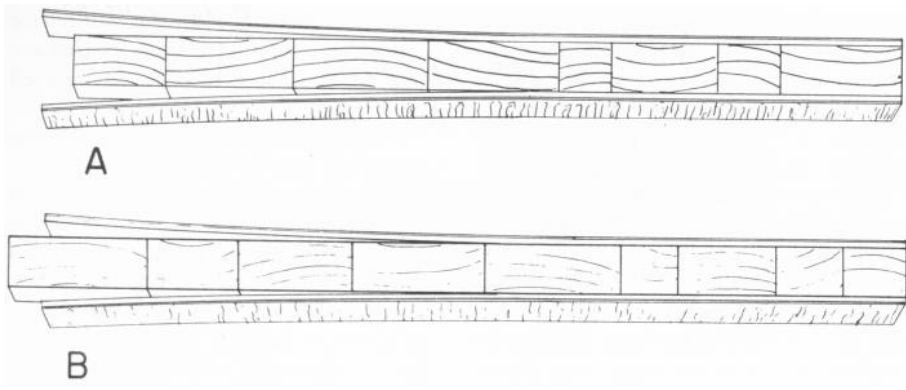

M 137 693

Figure 44.— If the panel had 7 to 8 percent moisture content when veneers (cross-bands and faces) were separated from the core, it is safe to assume that: A, moisture content of core was too high at time of gluing; B, moisture content in core was too low when panel was glued.

band and had picked up moisture since the panel was glued. By using the average shrinkage value for the species, the approximate moisture content of the core at the time the panel was glued can be calculated.

Careful inspection of panel surfaces, particularly for furniture panels, is also important in various stages of production. The sooner surface defects can be detected, the less labor is expended if the panel must be rejected. Incident lighting fixtures such

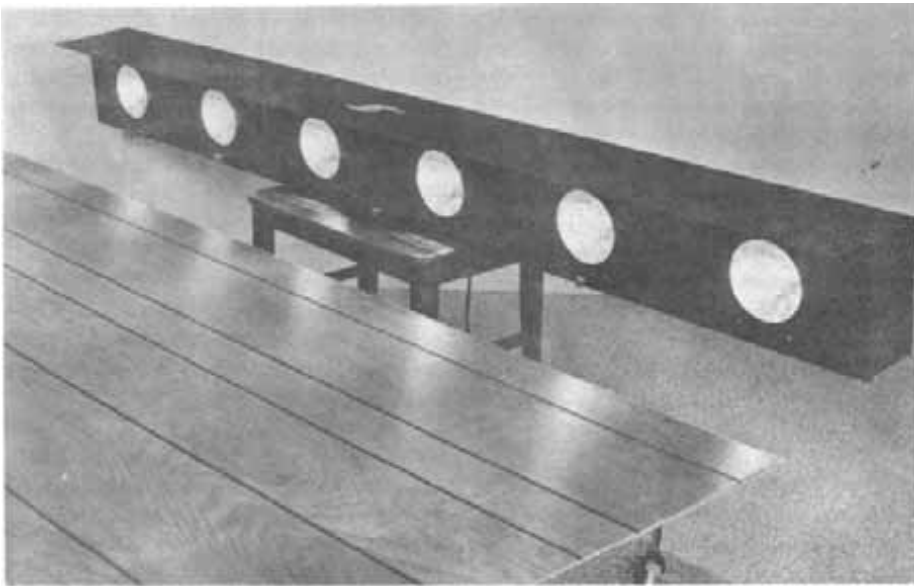

M 138 350

Figure 45.— Incident lighting fixture for detecting defects such as showthrough, checking, or other surface blemishes in panels.

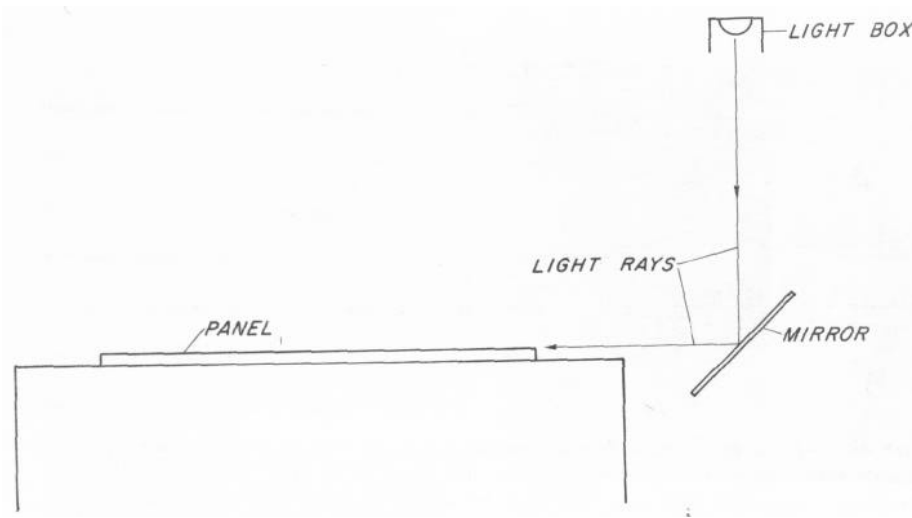

M 138 747

Figure 46.— Lighting arrangement used in some plywood plants to facilitate inspection of panel surfaces as panel emerges from sander.

as illustrated in figure 45 are very useful for such inspections. Figure 46 is a schematic sketch of a lighting device used at inspection stations in some plywood plants.

LAMINATED TIMBERS

Adhesives that set at room temperatures or at moderately elevated temperatures are most practical for laminated timbers of appreciable cross section. Casein and phenol-resorcinol are used for normally dry interior service (where moisture content of the wood is not expected to

exceed 16 pct. for an appreciable length of time) and phenol-resorcinol is used where the moisture content in use generally exceeds 16 percent.

For end jointing of laminations, melamine-urea (in a 60:40 ratio) is used for most interior laminates, and resorcinol or phenol-resorcinol is the preferred glue when the product is intended for exterior use. Co-sprayed melamine-urea has shown better durability than the two resins mechanically mixed.

Some of the major operations in the production of laminated timbers are illustrated in figures 47 to 54.



M 138 313

Figure 47.— Laying out template for an arch on mold-loft floor.

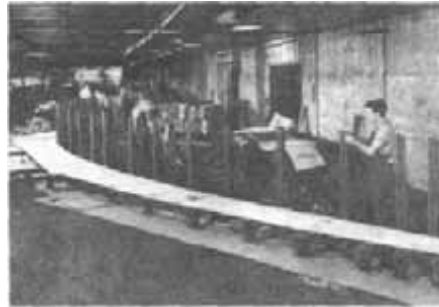

M 136 847-2

Figure 48.— Setting jig to fit template.

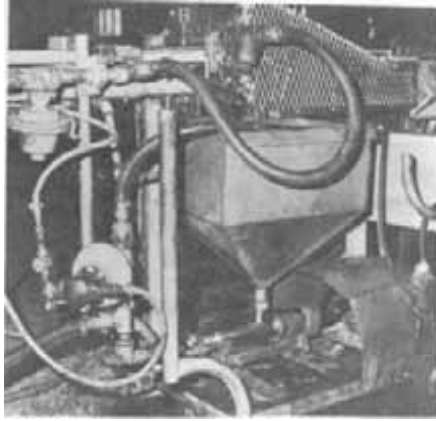

M 136 847-2

Figure 49.— Ribbon glue spreader. A, Plank receiving adhesive; B, ribbons of glue extruded from equally spaced holes on spreader pipe.

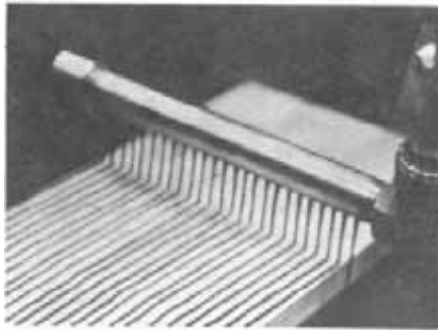

M 138 390

Figure 50.— Ribbon spreading of glue.

FURNITURE

A greater variety of species and joint designs are used in making furniture than in any other segment of the wood-using industries. Some of the denser species are hickory, oak, pecan, sugar maple, beech, birch, ash, walnut, elm, hackberry, and cherry. In the medium and lower density ranges are gum, poplar, ponderosa pine, alder, basswood, and mahogany.

The external load a furniture joint must withstand is usually difficult to determine. The internal stresses, induced by moisture changes, generally increase with wood

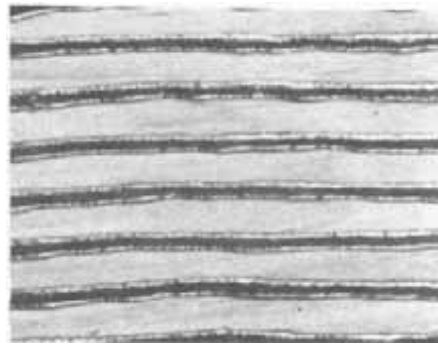

M 137 811

Figure 51.— Phenol-resorcinol adhesive applied by ribbon spreader. In the laminating industry, the laminations are often placed on edge (wide face vertical) during layup and pressure application; hence, the adhesive must be thixotropic to avoid running to bottom edge.



M 138 312

Figure 52.— Tightening clamps on glued assemblies with nut runner operated by compressed air.

density and amount of shrinkage and swelling the joint is exposed to. In the author's opinion, more furniture joints fail because of internal stresses than because of external load, or they weaken to a degree where external load brings on failure. It is important, therefore, that the furniture designer be intimately acquainted with the properties of the different woods, and

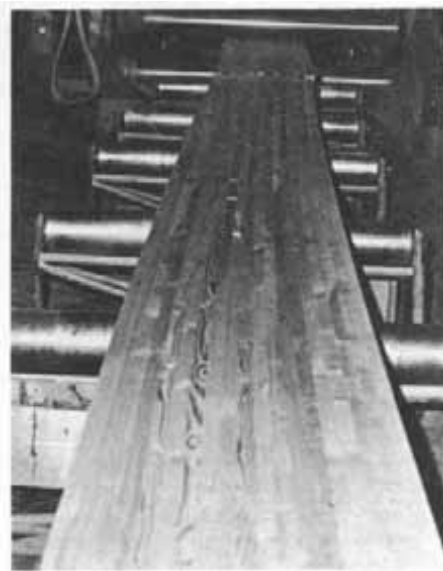

M 136 844-6

Figure 53.— Surfacing sides of slightly cambered laminated beams.



M 138 311

Figure 54.— Marking curved laminated member for trimming to outline of template.

know enough about adhesives to make the proper combination of wood, joint design, and bonding agent. Finish also plays an important part in the performance of glued wood products.

In a study on performance of certain types of furniture joints (fig. 55) bonded with different adhesives, the side-grain-to-side-grain joint, as would be expected, was

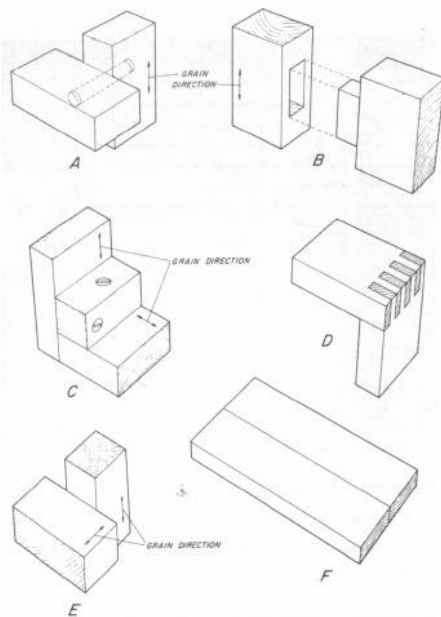

M 138 751

Figure 55.— Various types of furniture joints used in a study on effect of joint design and exposure on the performance of different types of glues: A, Dowel; B, mortise and tenon; C, blocked; D, slip (or lock); E, end grain to side grain; F, side grain to side grain.

least affected by cyclical high-low humidity exposures, and the block corner joint showed the greatest deterioration (fig. 56). Of the adhesives evaluated, resorcinol and phenol-resorcinol generally performed best. Animal glue and casein glue were in the upper range on side-grain-to-side-grain joints but were generally the least durable in other types of joints. Acid-catalyzed phenol and urea resin glues were generally intermediate in most joints, although there was considerable variation in the performance of the three ureas included in the study. Polyvinyl emulsion adhesive performed well in dowel and slip or lock joints but poorly in side-grain-to-side-grain joints.

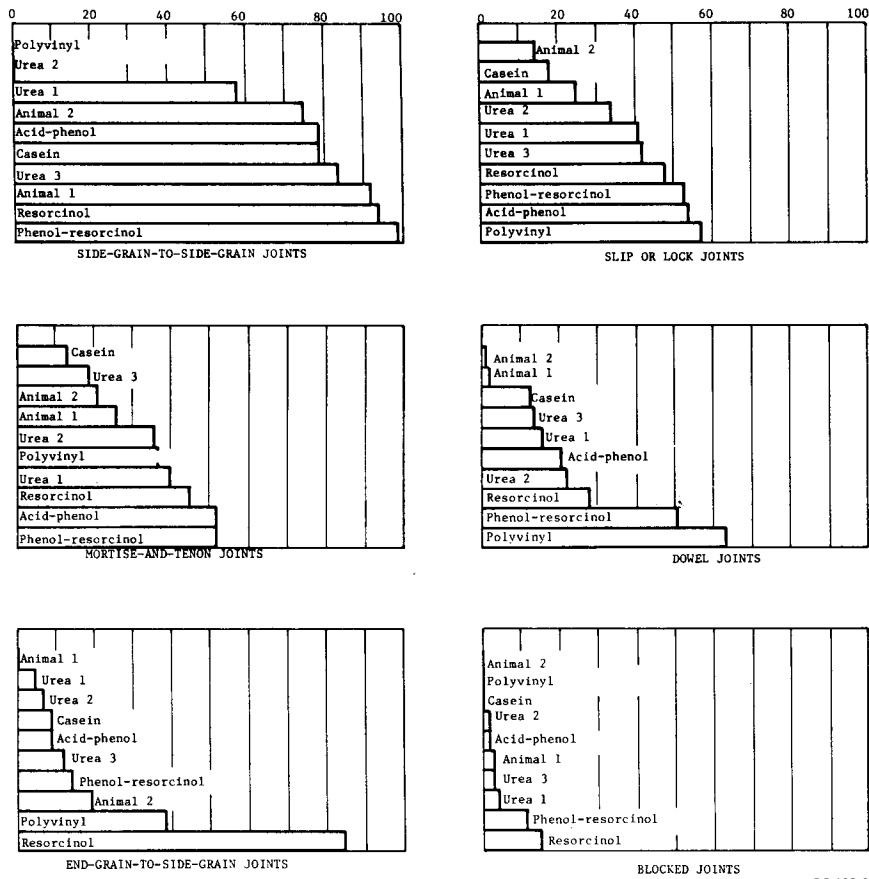

M 138 928

Figure 56.— Comparison of percentages of control strength values retained by different types of assembly joints after 36 months of exposure to a repeating cycle consisting of 4 weeks in air at 90 percent relative humidity followed by 4 weeks in air at 30 percent relative humidity, both at 80° F. (Two different commercial animal glues were tested, and urea adhesives from three different manufacturers were tested.)

Figures 57 and 58 illustrate the performance of two types of joints in two levels of exposure. Under the humidity exposure of 65-30 percent—approximately that for normal interior furniture use—side-grain-to-side-grain joints held up well with all glues. Where the grain was crossed, however (mortise and tenon, fig. 58), the casein glue (and others) deteriorated appreciably in the milder exposure and seriously in the more drastic humidity changes. The evaluations were made on

sugar maple without any finish or surface coating and no load was applied during cycling.

Urea resin is probably the adhesive most widely used for furniture. If good-quality urea adhesive is employed, satisfactory performance can be expected in reasonably well-maintained furniture.

For moist and tropical conditions, boil-proof adhesives such as resorcinol and phenol-resorcinol would provide the best long-term performance.

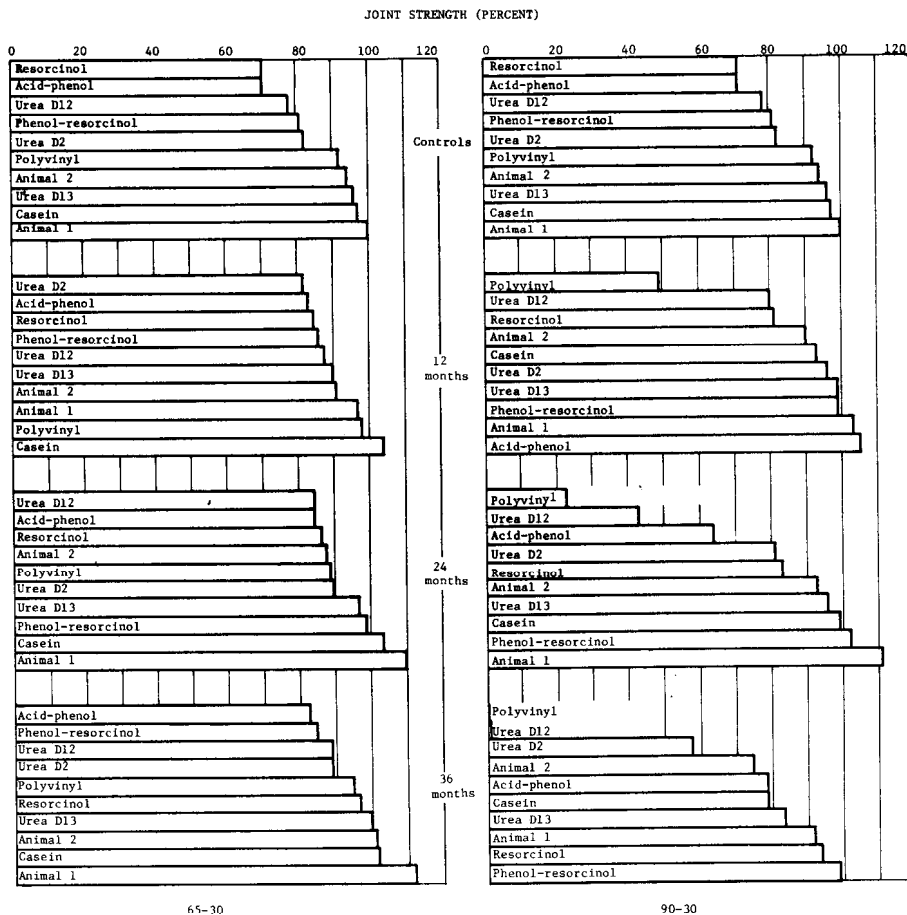

Figure 57.— Performance of various glues in side-grain-to-side-grain joints exposed to repeating cycles between 65-30 and 90-30 percent relative humidity, all at 80° F.

Polyvinyl resin emulsions, because of their flexibility, have performed well in certain types of joints (dowel, slip or lock joints). But where joints are continually stressed, polyvinyl resin emulsions should be avoided because of tendencies to creep. Also, their moisture resistance is low, which makes them unsuitable where high humidity prevails.

Thermosetting polyvinyls, particularly when cured at elevated temperature, are far superior in moisture resistance to the

ordinary PVA emulsions. However, they are reported to be subject to creep and probably would not be desirable for joints under appreciable continued external load.

Animal glues are still used to some extent for assembling furniture; if the proper care is taken both in gluing and finish upkeep, good performance can be expected in normally dry interior use. Although their moisture resistance is low and they deteriorate under high humidity exposure, in side-grain-to-side grain joints

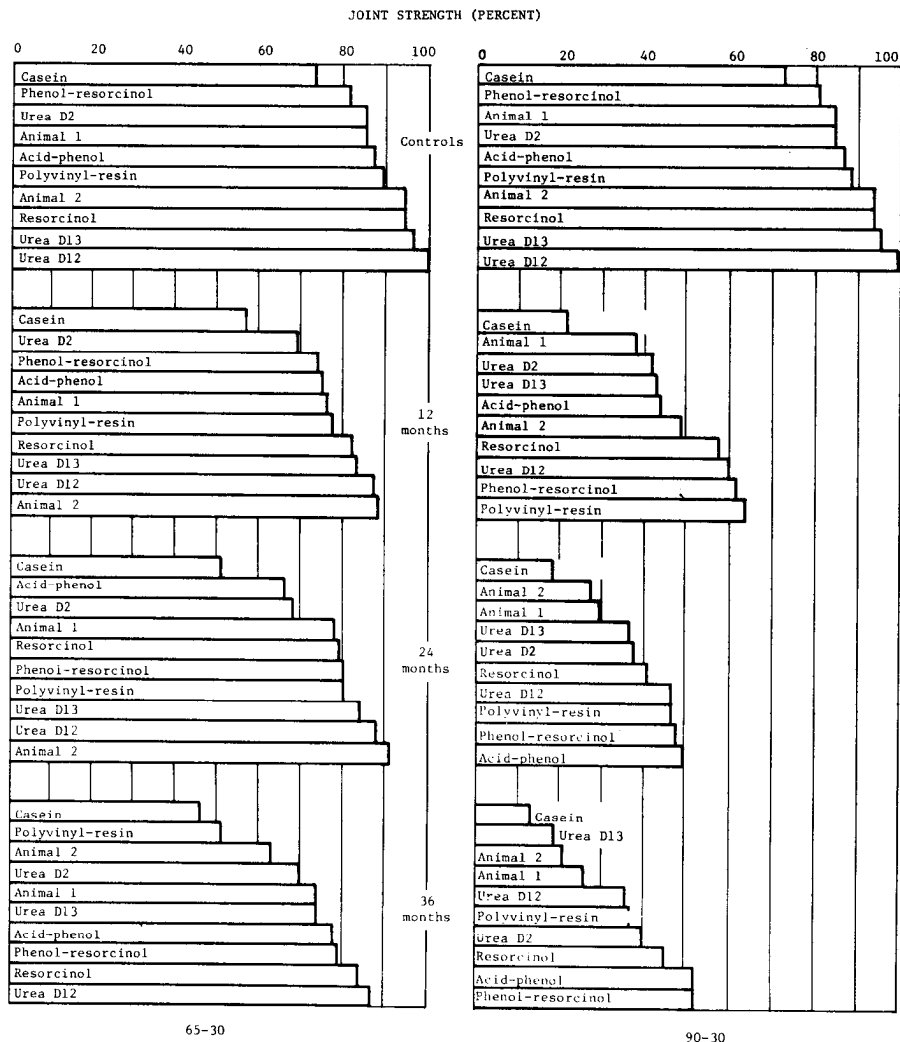

Figure 58.— Performance of various glues in mortise-and-tenon joints exposed to repeating cycles between 65-30 and 90-30 percent relative humidity, all at 80° F.

animal glues hold up reasonably well for short periods even at the higher humidities.

Use of hot melts is rapidly increasing because of the automated and increased production feasible with them. Many types and formulations are available, leaving little basis for any general statement on long-term durability at this time.

In operations where high-frequency heating or other means for elevated temperature curing are available, melamines and melamine-ureas would certainly deserve consideration in furniture manufacture. Of the two, melamine-urea cures faster and is lower in cost.

One of the older methods of gluing furniture panels, but still a commonly used

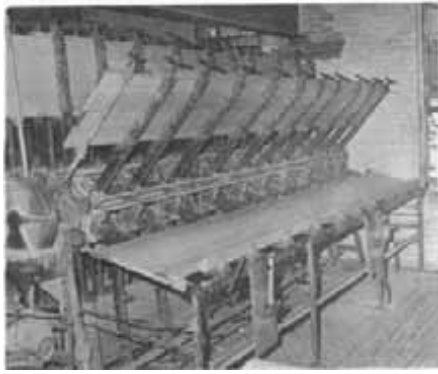

M 136 800-2

Figure 59.— Edge gluing oak for backs of church pews. Systems of this type (glue wheel) have been in use for decades.

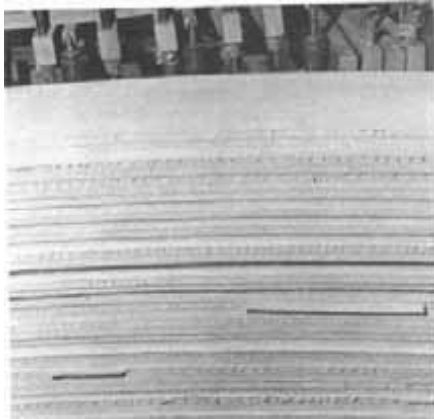

M 136 800-9

Figure 60.— Stack of laminated curved backs for church pews made of two $\frac{3}{4}$ -inch layers of particleboard and faced with oak veneer. Jig used for gluing is in background.

one, is illustrated in figure 59. It is applicable to room-temperature-setting glues, but moderate heat can also be applied while the “glue wheel” completes a cycle.

Figure 60 shows slightly curved backs for church pews made by laminating two layers of particleboard faced with thin veneers, and figure 61 shows middle and end supports (up-rights) for church pews produced by edge gluing.



M 136 801-2

Figure 61.— Edge-glued middle and end supports for church pews.



M 138 264-6

Figure 62.— Lay-up table for single-opening batch-process, edge-gluing press. Adhesive is heat cured.

Figures 62 and 63 illustrate edge-gluing operations for furniture panels produced by hot pressing. The panels are bonded with urea resin adhesive. Figure 64 shows a battery of cold presses for mass production of furniture panels and figure 65 shows a continuous-feed, steam-heated edge-

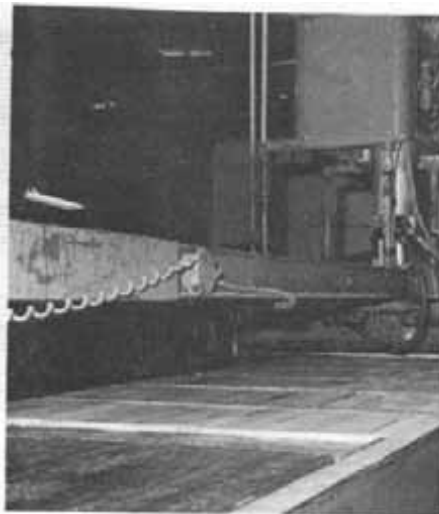

M 138 264-8

Figure 63.— Single-opening hot press for edge-gluing panels. The cured panels are. ejected as the new batch goes in.



M 139 072

Figure 64.— Cold-pressing panels for cabinet doors glued with modified PVA.



M 138 704

Figure 65.— Continuous-feed, steam-heated press for edge gluing. Edges of lumber spread with glue travel by conveyor to operator's position.

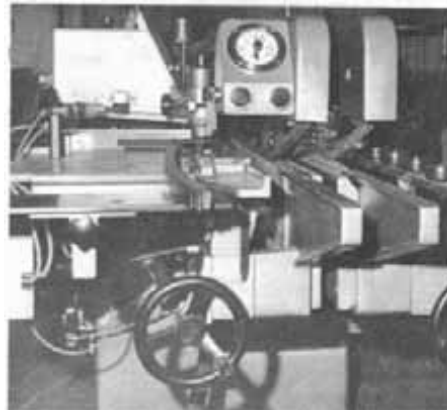

M 138 265-5

Figure 66.— Machine for applying edge banding to furniture panels with hot-melt glue.

gluing press. Figure 66 shows a machine for continuous edge banding of panels, employing hot-melt adhesive.

SHIP AND BOAT CONSTRUCTION

Gluing operations for ship and boat building fall essentially in three categories: (1) Laminating structural members (keels, frames, and deck beams-figs. 47 to 54



M 95398 F

Figure 67.— Jig for gluing U-shaped ship frame. The smaller members inside the frame were glued and clamped elsewhere and brought to the curing area by overhead crane. The enclosed heating unit and fan for circulating air are shown in background. A metal cover is placed on top of jig forming a complete enclosure during curing.

and fig. 67), (2) assembly gluing (plywood gussets for joining frames at chines and for joining deck beams to frames—fig. 68), and (3) production of marine plywood for bulkheads, decks, outer skin or planking, and superstructure (figs. 38 to 43).

For marine plywood, hot-press phenolic adhesives similar to those used for exterior plywood are employed. The only substantial difference between the two types of plywood is that certain defects permitted in veneers for exterior plywood are not allowed in the marine grade.

In ship and boat component production, such as laminating and assembly gluing, phenol-resorcinol adhesives are used almost exclusively. Since elevated temperatures for curing often are not feasible in assembly gluing, it is advisable to check with the glue manufacturer to determine if the adhesive is room temperature setting on the species involved. Rustproof screws or bolts are generally used for applying



M 99446 F

Figure 68.— Construction of V-bottom boat with frames joined at keel, chine, and deck with glued and bolted plywood gussets.

gluing pressure in assembly gluing of boats. Predrilled holes slightly reamed out on the contacting surfaces permit drawing the glued surfaces into closer contact.

For laminated ship and boat members, white oak is often used because of its high impact resistance and durability (fig. 69). White oak is one of the higher density native species and requires high-quality adhesive, generally of the phenol-resorcinol type. Sufficient assembly period should be used to allow the viscosity of the glue to build up to the proper level. Elevated curing temperatures, about 150° F. for 6 hours, are generally required with current adhesives, but lower curing temperatures may be used with extended curing periods (fig. 11).

DOORS

Wood doors vary in size from small cabinet doors to large garage or warehouse units, and in construction from flush panels with hollow or solid cores (figs. 70 to 72) to panels with frames, usually called stiles and rails. Details will not be discussed here, but a few precautions will be pointed out to aid in avoiding pitfalls that

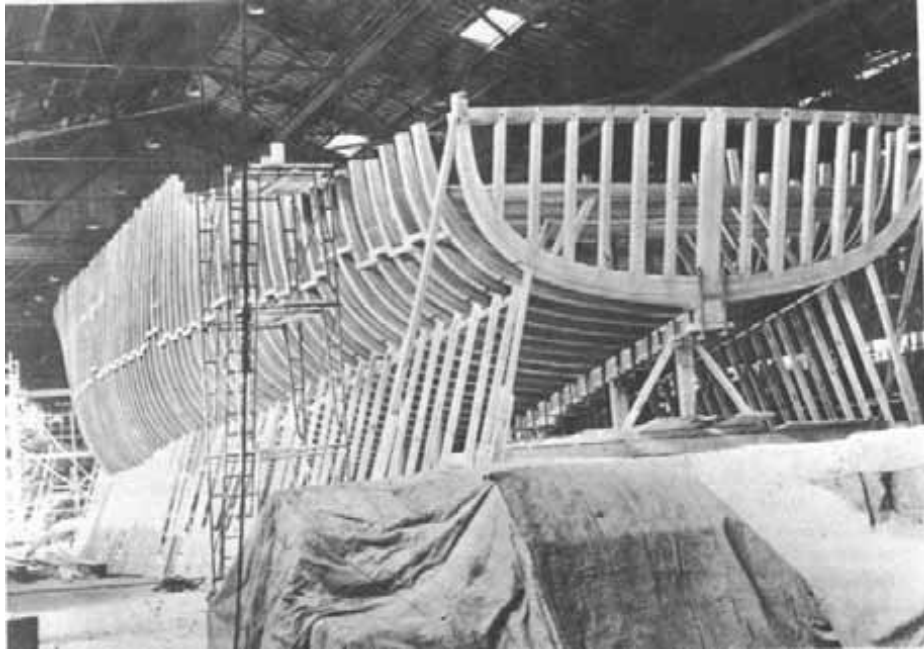

M 94561 F

Figure 69.— Laminated white oak frames used in construction of Navy minesweeper.

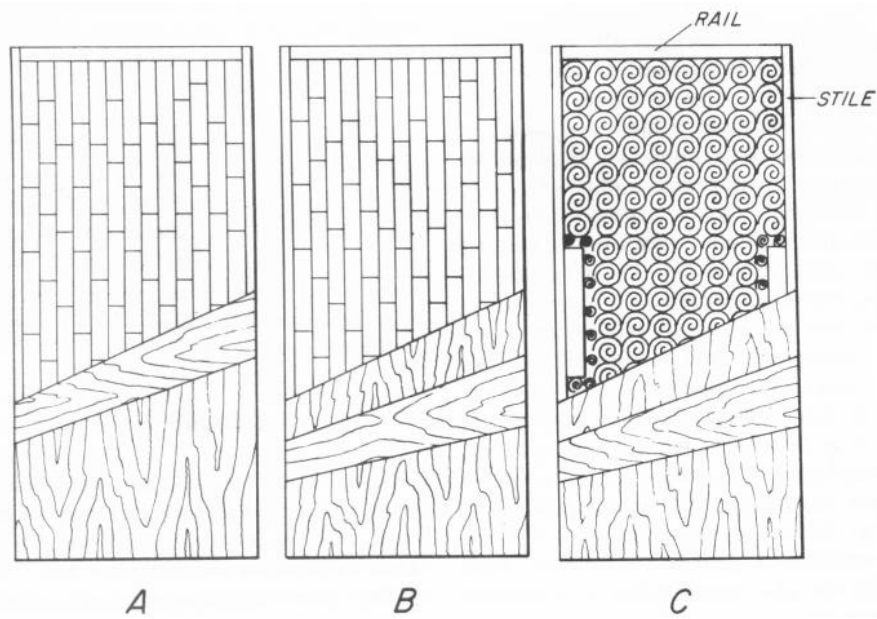

M 138 750

Figure 70.— Three types of flush doors. A, Five-ply, solid-core; B, seven-ply, solid-core. The three-ply faces (door skins) are usually preglued; C, seven-ply, hollow-core door. Core material in this case is wood shavings produced by special process.

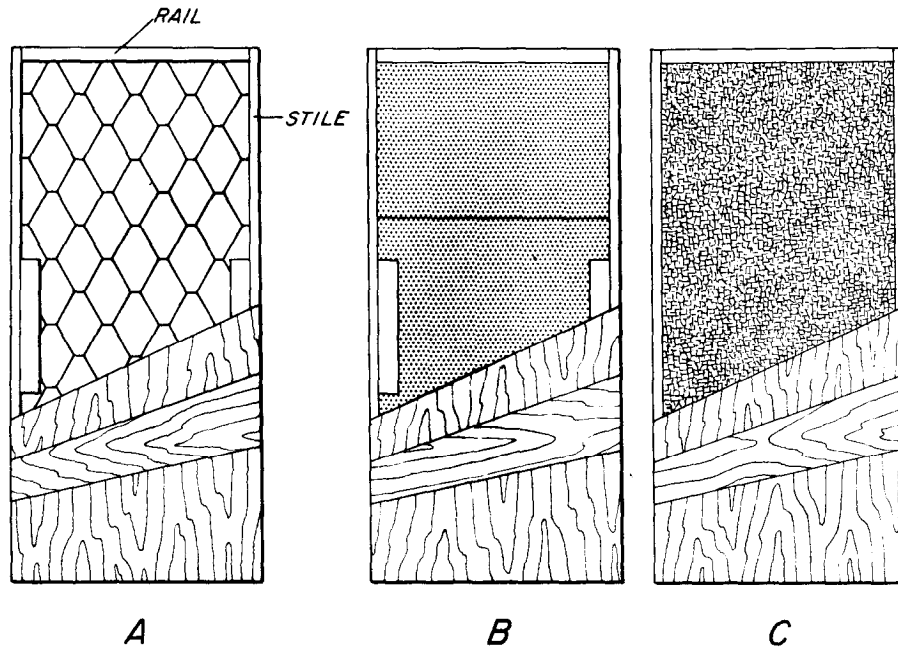

M 138 749

Figure 71.— Flush doors with three-ply plywood faces. A, Expanded cell-type core; B, mineral composition core; C, particleboard core.

have resulted in unsatisfactory door performance.

Flush doors are often made with “door skins” for faces. These door skins are generally three-ply plywood about 1/8 inch thick. The inner ply or core of this plywood is generally of a lower grade than the faces. When such plywood is used for door skins, the core becomes very important in controlling warping characteristics of the door; in the seven-ply construction that constitutes the door, the two center plies in the door skins are the crossbands for the entire panel. The importance of straight and parallel grain in avoiding warping is discussed earlier in the section titled “Crossbanded Construction.”

Solid cores for flush doors are often made of short blocks glued edge to edge, but not end glued. If the outline of these blocks can be observed on the face of the door (showthrough), the cause is usually unequal shrinking or swelling of adjacent

blocks. This can result from placing vertical-grain blocks adjacent to flat-grain blocks in the core or from using blocks of unequal moisture content at the time the door is glued. Low-shrinkage species such as ponderosa pine are less likely to cause showthrough of core blocks than higher shrinkage species such as Douglas-fir. Thick crossbands are also more beneficial in preventing showthrough than thinner ones.

In panel doors, straight-grained framing material of moderate shrinkage is less likely to cause warp than higher density material, particularly if the latter contains cross grain. If the panels are glued to the frame, they are also apt to warp with changes in moisture content.

Recently panel doors have been produced where the edges of the panels are set in soft plastic foam. This permits dimensional changes in the wood without air leaking through open joints and also eliminates

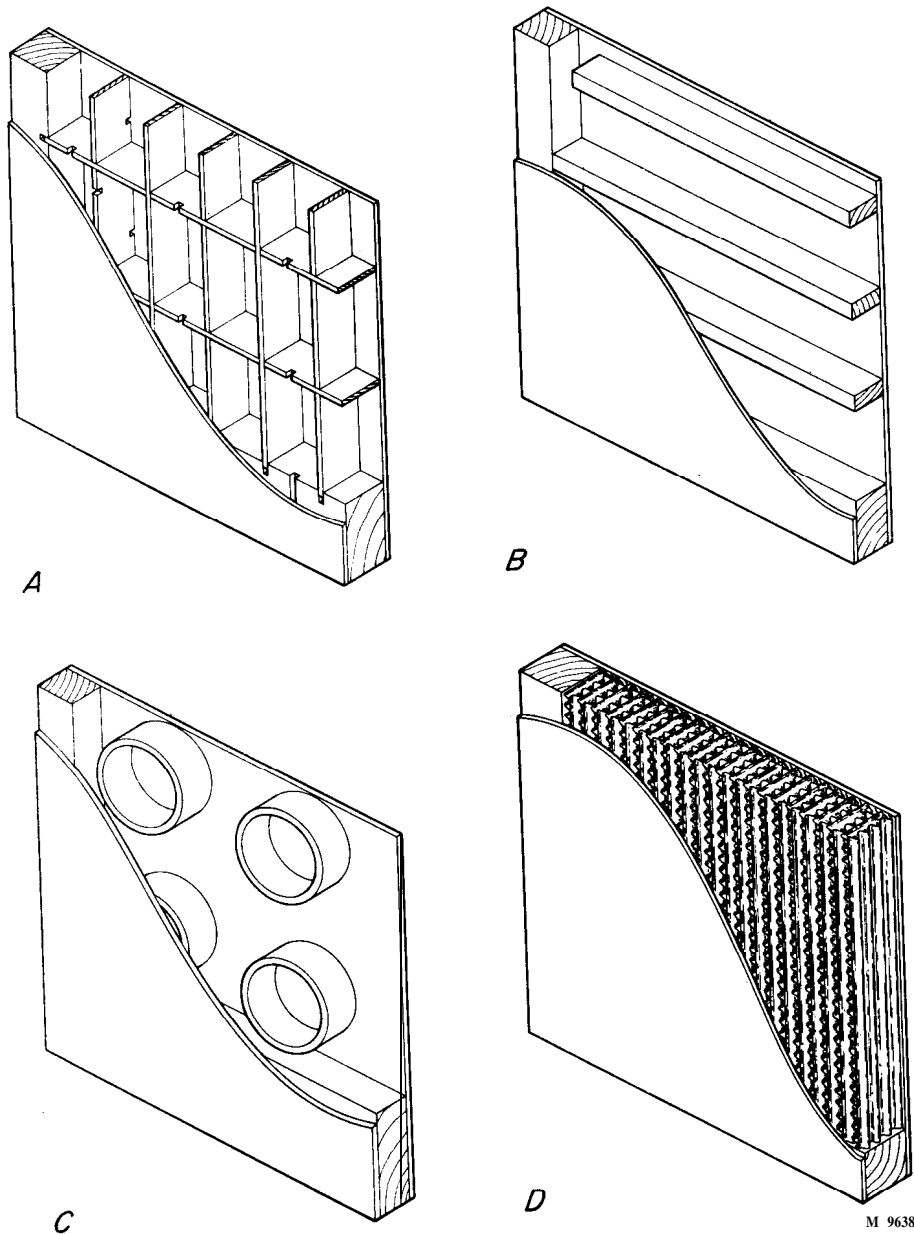

M 96381

Figure 72.— Typical core types used in hollow-core doors. A, lattice; B, ladder; C, tube; D, honeycomb.

warping caused by shrinkage and swelling of the panels.

Adhesives in doors for interior use are generally of the water-resistant types (urea,

casein). Exterior doors, unless completely protected by wide overhangs, should have waterproof glue bonds of the quality used for exterior plywood (phenolics).

SPORTING GOODS

Glued products used for sports include bowling pins, tennis rackets, snow skis, water skis, hockey sticks, and various types of gym equipment. Laminated baseball bats (fig. 73) have also been produced.

These items generally are subject to rough usage and must be made of tough, strong woods. Such woods usually exert high stresses on the glue joints under loss or increase in moisture content. For long-lasting, safe products, adhesives of good quality are needed.

For items such as water skis, a waterproof bond is definitely required to obtain reasonable service life for the product.

Bowling pins are subject to severe impacts and a tough adhesive would be expected to give the best performance. But because bowling pins never get wet, and generally have a heavy plastic coating, the ultimate in water resistance is not needed. One manufacturer of laminated bowling pins successfully used a separate application of urea resin (catalyst applied to one face and the resin to the other) for many years.



M 84744 F

Figure 73.— Laminated baseball bats with center lamination of hickory for improved impact strength and the remaining sections of ash with edge grain exposed on the surface of the bat. Edge-grained surfaces make the bat more resistant to shelling.

The risk involved in using a moisture-sensitive adhesive would be if such laminated equipment, intended for normally dry use, would be stored in a damp warehouse for an extended period.

Where facilities for curing at elevated temperatures are available, a melamine- or resorcinol-fortified urea would provide a greater margin of safety than straight urea resin as far as durability of glue bonds is concerned.

Where steel or fiberglass are combined with wood, as in some snow skis, an epoxy formulated for this purpose may be the best choice.

PARTICLEBOARD

Urea resin is used almost exclusively as binder for interior particleboard. Since the wood is broken down into small particles, the stresses on the minute bonds are probably lower with changes in moisture content than in a solid wood-to-wood joint. On the other hand, it is well known that urea-bonded particleboard deteriorates in a few years when exposed directly to the weather. This indicates that urea resin is not a suitable binder for particleboard where damp or humid use conditions are involved.

For exterior boards, phenolic binder is employed but no substantial use has been made of particleboard for exterior service in this country.

Particleboard has also been made with melamine resin binder, and at least on an experimental basis, with extracts from bark. Binder generally is applied by air spraying or airless spraying with agitation of the particles.

When veneering particleboard or bonding particleboard to itself or to wood, an adhesive fully as durable as the binder used in the boards should be used. For normally dry interior applications, urea resin should be adequate; for uses such as light cabinet doors, high-quality polyvinyl glue has been reported to give good service. A good moisture-excluding finish reduces stresses

on the glue bonds and is a good safety factor, particularly when panels are used in kitchens and bathrooms where intermittent high humidity often occurs.

HOUSING AND HOUSING COMPONENTS

Glues for floor and wall panel applications (figs. 74 and 75) are generally of the elastomeric or mastic type and are based on rubber, polyurethanes, and other materials. They are usually furnished ready for use in small cartridges (cylinders) that fit caulking guns; they may be applied as a bead to studs and joists, or to smooth walls when wood paneling is applied to existing walls (fig. 76). Pneumatic glue guns are also available for more efficient application.

The glues are smoothed by the nail pressure (or by hand rollers where no nails are used); but because of their gap-filling properties, a thin, uniform glue film as obtained with well-fitted joints formed under pressure is not necessarily required. On an experimental basis, paneling has



M 138 198

Figure 75.— Application of mastic adhesive to studs for bonding wall panels.



M 138 196

Figure 74.— Application of mastic adhesive for bonding plywood to joists. The plywood is also nailed, which furnishes gluing pressure.

also been applied merely by pressing the panel (by roller) against the wall to smooth out the glue without the benefit of nails.

Wall panels are sometimes nailed only at top and bottom (where nail holes will be covered by molding or baseboard) and the remainder of the panel is brought into close contact with the studs with hand rollers to establish the glue bond.

Advantages of using glue in applying wall panels include providing racking resistance to the walls and, where decorative panels are involved, avoiding unsightly marring of beautiful panels by nailing and nail popping.

Nail-glued plywood floors reportedly permit wider joist spacing or smaller joists than floors only nailed. Another important advantage claimed for this system is elimination or reduction of floor squeaks.



M 138 597

Figure 76.— Application of press-dried lumber paneling to plastered wall with mastic-type adhesive. left: Fitting panel to the adjacent one. Right: Applying adhesive to wall with caulking gun.

Housing components such as trusses and wall and floor sections have been factory-made for many years. Because of adverse exposure that can often occur during shipment and erection, a waterproof adhesive (resorcinol or phenol-resorcinol) is recommended for gluing such components. Since combinations of lumber and plywood are often involved, appreciable stresses on the joints with seasonal moisture changes are almost unavoidable. This is another reason for advocating highly durable adhesives for housing component manufacture.

Various means for pressing and curing the glue joints in components have been devised. Low-voltage heating is one of the common methods. It is also possible to

produce adequate glue bonds in certain members by nail-gluing and allowing the resin adhesive to set at room temperatures. The nail-glued truss shown in figure 77 is a typical building unit produced by this method.

Two major advantages of preglued components are reduced labor cost at the site and higher quality building units (improved strength by gluing). In the factory, jigs can be employed to provide both uniformity of dimensions and rapid assembly of parts. The conditions for obtaining high-quality glue joints are also much more favorable in the plant where temperature of both materials and surroundings can be controlled.

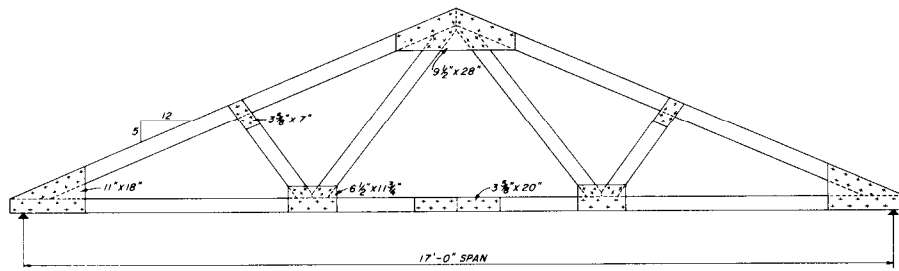

ZM 96227 F

Figure 77.— Light truss with plywood gusset plates glued to framing members. The gussets were $\frac{1}{2}$ -inch, five-ply, exterior-grade Douglas-fir plywood; framing members were $1\frac{5}{8}$ by $3\frac{5}{8}$ inches in cross section; and ninepenny nails (indicated by + on sketch) were used to apply gluing pressure.

NEW PRODUCTS

With use of adhesives steadily on the increase, new bonded wood products—or combinations of wood and other materials—are continuously coming on the market.

Wood “jewelry” in many varieties is generally made by bonding the shaped wood parts to metal clips or similar fasteners with epoxy adhesive. When a clear epoxy is used, a complete coating of the wood part can also provide a durable finish.

Laminated flooring of various constructions has been made for many years, but new adhesive bonding techniques are developed from time to time. A method of obtaining two three-ply flooring boards by gluing and pressing one five-ply plank is illustrated in figure 78. This type of flooring, made of softwoods with oak top face, is produced in Scandinavia.

Details of construction of a four-ply, laminated flooring produced for many years in Europe are shown in figure 79.

Oak-faced flooring for use in permanent construction should be bonded with an adhesive at least as durable as fortified urea. Where appreciable fluctuations in moisture content or where high humidity and temperature conditions prevail, a phenol-resorcinol would provide greater assurance of long-term satisfactory performance.

Experimentally, bonding various types of overlays to wood has improved appearance, paintability, and other properties, and heavier decorative overlays for kitchen tables and cabinet tops have been produced for several decades. Quite a range of adhesives from ureas to resorcinols, depending on the moisture resistance required, bond these overlays to panel products. Contact

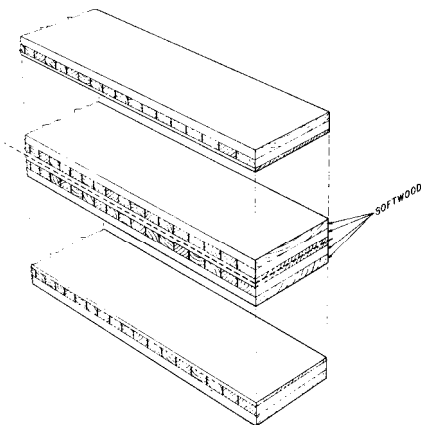

M 138 530

Figure 78.— Single gluing operation and resawing yield two three-ply flooring boards (top and bottom of sketch) from one five-ply unit (center). Oak lamination is sawn at dashed line and the surface of each half becomes the top flooring surface.

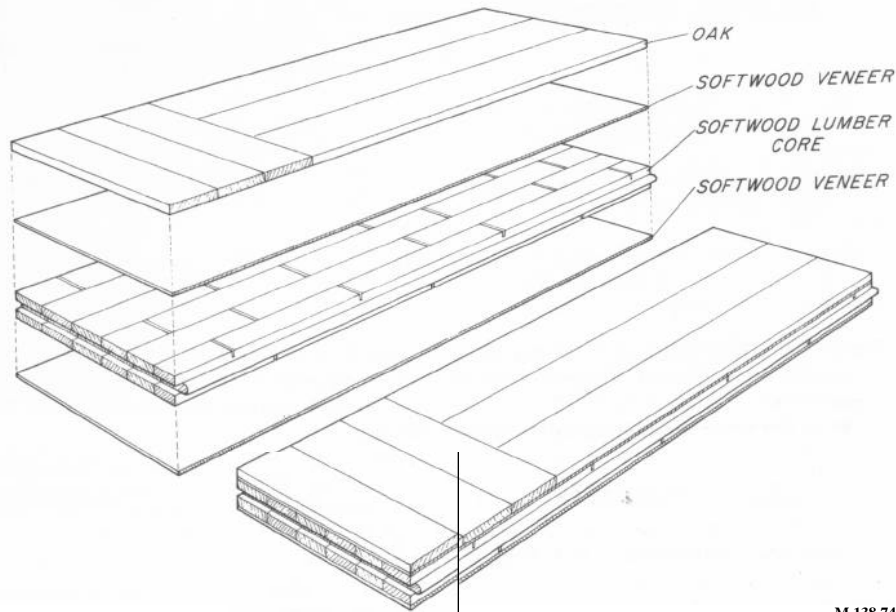

M 138 745

Figure 79.— Sketch of glued flooring made with softwood lumber core faced with wood veneer and a top layer made up of narrow strips of oak laid in various parquet designs. The finished boards are furnished in about 6- by 120-inch strips, tongued-and-grooved, and varnished on the top surface.

adhesives applied to both the overlay and the panel products also are widely used for this purpose; they are particularly convenient for do-it-yourself and on-the-job applications where equipment for applying pressure over large areas is usually not available.

Use of vinyl overlays for such items as moldings and furniture parts has been increasing the past few years. These overlays (vinyl films) are produced with wood grain patterns; thus woods not usually suitable for molding can be given the appearance of walnut or other high-quality wood. These films are furnished with or without adhesive applied to the film and the adhesive composition is usually not disclosed.

Figure 80 illustrates one type of equipment for applying flexible vinyl overlay. With adjustable soft rolls, the film can be applied to molding and other items of a variety of profiles.

As with products of established performance, species, finish, use conditions, and expected service life must be considered when choosing an adhesive for a new product.

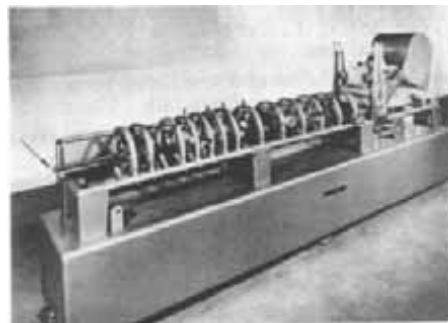

M 138 351

Figure 80.— Machine for applying flexible overlay (vinyl film) to molding and similar stock. Arrow points to overlaid stock coming through the machine.

SELECTED REFERENCES

- Adhesives Age
1964. Fibrous overlay bonded to wood at high speeds. *Adhes. Age* 7(5):25.
- Adhesives Age
1965. Glued walls for a new building. *Adhes. Age* 8(2):36-37.
- Adhesives Age
1965. Sprayable adhesive reduces drywall lamination costs. *Adhes. Age* 8(6):27.
- Anderson, A. B., Breuer, R. J., and Nicholls, G. A.
1961. Bonding particleboards with bark extracts. *For. Prod. J.* 11(5):226-228.
- Bergin, E. G.
1969. The strength and durability of thick gluelines. *Can. For. Serv. Publ. No.* 1260, 24 p.
- Carroll, Murray
1963. Efficiency of urea and phenol formaldehyde in particleboard. *For. Prod. J.* 13(3): 113-120.
- Cass, Stephen, B., Jr.
1961. A comparison of hot press interior plywood adhesives. *For. Prod. J.* 11(7):285-287.
- Clausen, Victor H., and Zweig, Arnold
1969. Automatic plywood layup development at Simpson Timber Company. *For. Prod. J.* 19(9):62-73.
- Ettling, B. S., and Adams, M. F.
1966. Quantitative determination of phenolic resin in particleboard. *For. Prod. J.* 16(6):25-28.
- Freas, A. D., and Selbo, M. L.
1954. Fabrication and design of glued laminated wood structural members. U.S. Dep. Agric., *Tech. Bull.* 1069. 220 p.
- Gatchell, C. J., and Heebink, B. G.
1964. Effect of particle geometry on properties of molded wood-resin blends. *For. Prod. J.* 14(11):501-507.
- Heebink, B. G., Kuenzi, E. W., and Maki, A. C.
1964. Linear movement of plywood and flakeboards as related to the longitudinal movement of wood. U.S. For. Serv. Res. Note FPL-073. 34 p. U.S. Dep. Agric. For. Serv. For. Prod. Lab., Madison, Wis.
- Jarvi, R. A.
1967. Exterior glues for plywood. *For. Prod. J.* 17(1):37-42.
- Klein, W. A.
1970. How to laminate particleboard with adhesive-coated vinyl film. *Adhes. Age* 13(12):26-27.
- Lehmann, W. F.
1965. Improved particleboard through better resin efficiency. *For. Prod. J.* 15(4):155-161.
- Lehmann, W. F.
1968. Resin distribution in flakeboards shown by ultraviolet light photography. *For. Prod. J.* 18(10):32-34.
- Lehmann, W. F.
1970. Resin efficiency in particleboard as influenced by density, atomization, and resin content. *For. Prod. J.* 20(11):48-54.
- Miller, D. G.
1953. Curved plywood, its production and application in the furniture industry. *For. Prod. J.* 3(2):22-26.
- Neusser, H.
1967. Practical testing of urea resin glues for particleboard with a view to shortening pressing time. *Holzforsch. u. Holzverwert.* 19(3):37-40. Wien.
- Page, W. D.
1968. Controlled manufacture of plywood structural components. *For. Prod. J.* 18(11):19-21.
- Pinion, L. C.
1967. Estimation of urea formaldehyde and melamine resins in particleboard. *For. Prod. J.* 17(11):27-29.
- Rice, J. G., Snyder, J. L., and Hart, C. A.
1967. Influence of selected resins and bonding factors on flakeboard properties. *For. Prod. J.* 17(8):49-56.
- Selbo, M. L.
1967. Long-term effect of preservatives on glue lines and laminated beams. *For. Prod. J.* 17(5):23-32.
- Selbo, M. L.
1954. Jig for alining scarf joints. *Proc. For. Prod. Res. Soc. J.* 4(4):43A-45A.
- Selbo, M. L.
1961. Adhesives for structural laminated lumber. *Adhes. Age* 4(2):22-25.
- Shen, K. C.
1970. Correlation between internal bond and the shear strength measured by twisting thin plates of particleboard. *For. Prod. J.* 20(11):16-20.
- Snider, Robert F.
1960. What to look for in glues for furniture production. *Adhes. Age* 3(1):38-40.
- Webb, D. A.
1970. Wood laminating adhesive system for ribbon spreading. *For. Prod. J.* 20(4): 19-23.

GLUING OPERATION

The gluing operation generally consists of these steps: (1) Mixing the ingredients that make up the glue, when ready for use; (2) spreading the glue on one or both joint surfaces to be bonded; (3) assembling the individual parts in the order planned for the bonded product; (4) allowing the spread glue to thicken and penetrate the wood surfaces for a certain period (usually referred to as the open and closed assembly periods and as a rule specified by the supplier); (5) applying pressure to bring the spread surfaces into close contact; (6) retaining pressure until the bond gains sufficient strength to permit safe handling of the glued product; and (7) conditioning the glued stock to complete adhesive cure and allow any solvent to diffuse throughout the glued assembly.

Each step will be discussed in more detail, but inasmuch as the gluing procedures vary considerably for different products, the discussion must necessarily be somewhat general. It is suggested therefore that the adhesive user follow the manufacturer's instruction very closely, and that the manufacturer's technical serviceman familiarize himself with the customer's process and product so he will be able to give sound advice to the customer.

MIXING ADHESIVE

Some adhesives, such as the film types and the straight polyvinyls, are furnished ready for use and hence require no mixing. Others, as the ready-to-use caseins and some powdered ureas, need only to be mixed with water, as prescribed by the glue supplier.

In this operation, usually part of the water is first run into the mixer, after

which the powder is added gradually with the mixer running to prevent formation of lumps. After a smooth, homogeneous mixture is obtained, the remaining water is added slowly with the mixer running. If all the remaining water is added at once, the doughlike mix might break into large lumps; such lumps, particularly with low-viscosity adhesives, may be extremely difficult to break up even with vigorous mixing.

This procedure is also sometimes necessary when a powdered hardener (often is a mixture of the actual hardener and an inert powder such as walnut shell flour or wood flour) is mixed with a liquid resin. It is often easier to obtain a homogeneous mix if the hardener is first mixed with part of the resin until a smooth mixture is obtained, and then the remainder of the resin is added gradually with stirring.

The glue supplier generally furnishes instructions for mixing and weighing the ingredients to be mixed. Mechanical mixers of various types (figs. 81 and 82) are invariably used in industrial operations; in the home workshop, small amounts can be mixed satisfactorily by hand, using a clean metal or glass container and a paddle for stirring. Since many adhesives are either mildly acid or alkaline, containers not affected by acid or alkali should be used. Strict cleanliness of gluing equipment is important for extraneous materials can easily lower the bonding quality of the adhesive. A mixer suitable both for laboratory and small shop use is shown in figure 83.

Some resins must be kept cool during storage and also at the time of mixing. Instructions to this effect are generally furnished by the supplier.

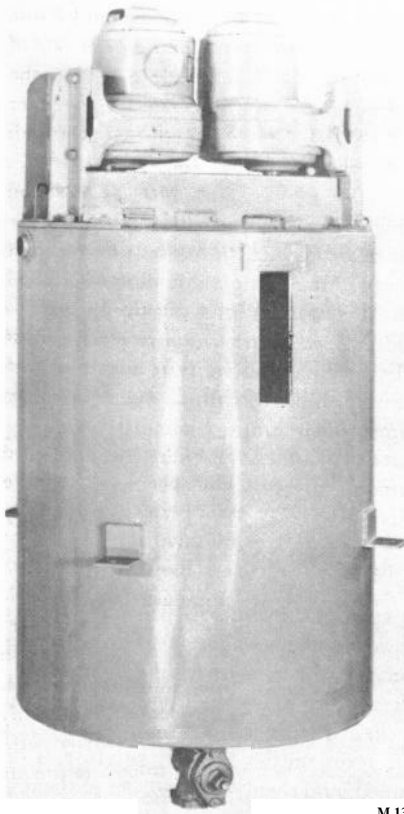

M 138 385

Figure 81.— Counter-rotating paddle-type mixer for protein and resin adhesives. Mixers are available in various sizes.

Sometimes, particularly during cool weather, resin adhesives should be allowed to mature for a short period between mixing and use. During hot weather the reaction period usually can be omitted. To avoid exceeding the working life of the mixed glue, mix smaller batches during hot weather than in the cooler seasons. This will prevent shutdowns for cleaning spreaders and other equipment because glue has exceeded its working life. Jacketed mixers permit the temperature of the mix to be controlled by running water of the required temperature through the jacket (fig. 82).

Automatic mixers are also available for certain applications, as shown in figure 84.

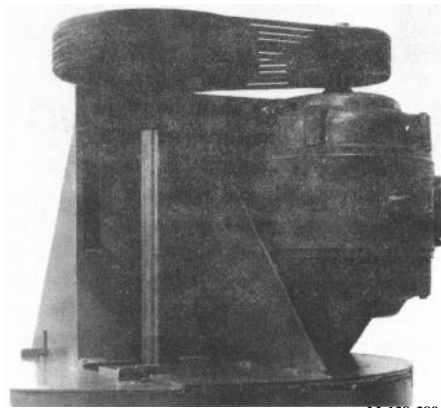

M 138 389

Figure 82.— Blender-type mixer for resin adhesives. The mixer is available with or without water jacket for cooling or warming the mix.

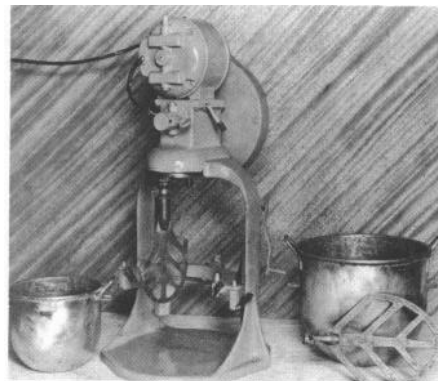

M 48436 F

Figure 83.— Three-speed mixer with two sizes of paddles and mixing bowls, suitable for laboratory and shop use.

SPREADING ADHESIVE

Various methods are used to apply adhesive to joint surfaces when bonding wood, depending largely on the type and amount of glued product and also to some extent on the adhesive.

In the small workshop, application by brush is often practical. When larger

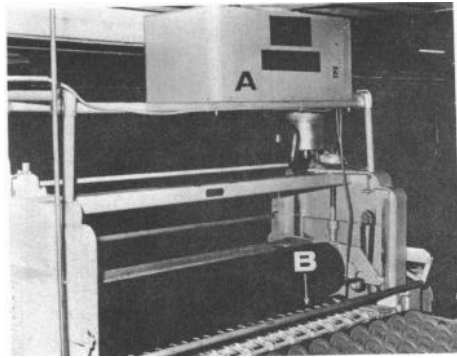

Figure 84.— Glue mixing and spreading equipment. A, Unit that automatically mixes liquid urea and powdered catalyst in the right proportions; B, glue spreader.

surfaces are involved, a mohair paint roller works well with many adhesives and is more efficient than a brush.

Mastic adhesives used for bonding panels to studs and joists are applied in beads by hand-operated caulking guns (figs. 74, 75, 76) or by compressed air-operated guns for more efficient operation.

In furniture manufacture where polyvinyl glues are sometimes used extensively, the liquid glue is distributed by pumps or gravity feed through pipes, often applied from nozzles conveniently located within the workmen's reach.

In larger gluing operations, such as in plywood and laminated timber production, application by double-roll spreaders (fig. 41) equipped with doctor rolls for close control of the spread has been common for decades.

In recent years, curtain coating, a method similar to the process used for pre-finishing plywood, has come into use in plywood manufacture (fig. 42). Curtain coating is claimed to result in more uniform spread and less waste of adhesive. Reportedly, adhesives are also applied by extruders in some softwood plywood plants.

In the laminating industry, ribbon spreading or extrusion spreading (figs. 49

and 50) is said to save adhesive and result in more uniform spread and greater rate of production. Ribbon spreading permits the laminations to travel under the extruder at a greater rate of speed than through a roll spreader. Since the spread surfaces are often placed in a vertical position during the assembly period, ribbon spreading requires a thixotropic adhesive that will not sag or run to the bottom edge of the laminations before gluing pressure is applied (fig. 51). The adhesive also must remain sufficiently fluid to smooth out in a uniform film when gluing pressure is applied.

The amount of spread (usually expressed in pounds of wet glue per 1,000 square feet of glue-joint area) varies considerably with the type of adhesive used, product being bonded, species, moisture content of the wood, and the temperature and humidity of the gluing area. In general, appreciably higher spread is required with casein glue than with most synthetics. Small items that can be assembled rapidly can often be bonded satisfactorily with less spread than large members requiring a long assembly period. Often adjustments in the adhesive (such as setting rate) must be made for different size products. Dense woods generally require heavier spreads than lighter ones (assembly time and other factors may also need adjustment). Wood at low moisture content absorbs the solvent from the adhesive faster than wood at higher moisture content; this makes increased spread necessary, unless assembly time is short.

High temperature and low humidity in the gluing area also suggest increases in the glue spread. This again depends on whether the assembly period can be shortened to compensate for the faster drying and "skinning" over of the glue film.

As a rule, only one of the mating surfaces of a joint is spread with adhesive. With certain products, however, such as large laminated members that require considerable time to assemble, spreading both surfaces of each lamination can be advanta-

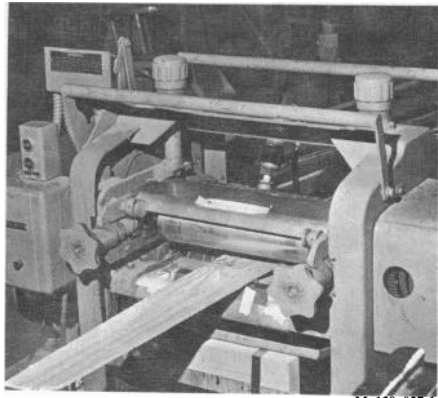

M 139 027-1

Figure 85.— Spreading resin glue on both faces of board with a rubber-covered double-roll spreader. Spreader has adjustable speed to accommodate different types of resins.

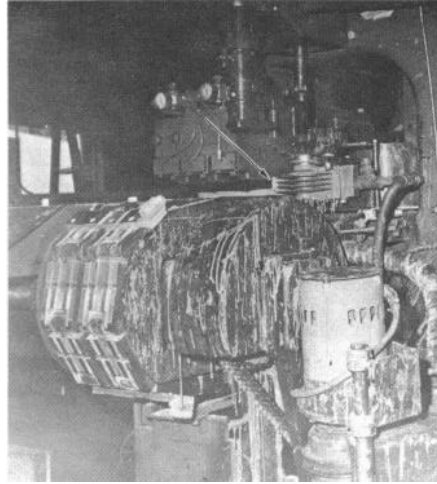

M 136 846-8

Figure 86.— Glue spreading mechanism for finger joints. Glue is dispensed at arrow.

geous. This is called “double spreading” (fig. 85).

Special joints, such as finger joints, require spreading mechanisms of the same profile as the joint for uniform application of adhesive. Such a spreader is shown in figure 86.

ASSEMBLING PARTS

Because of the large variety of glued wood products, only a few will be briefly mentioned to give a general idea of the assembly operations involved.

The key to success in most industries today is automation, and significant breakthroughs have been made in recent years in fields such as plywood manufacture where layup efficiency has improved immensely. In a similar manner, layup of large assemblies in the more progressive lumber-laminating plants is being done with hardly a piece of lumber being touched by hand.

In some plants the planer and glue spreader are arranged in tandem with synchronized rates of speed. The laminations, end-jointed to length, run conti-

nuously through both machines to the layup station.

ASSEMBLY TIME

The interval between spreading the adhesive and the application of full gluing pressure is called assembly time. If wood surfaces coated with glue are exposed freely to the air, solvent evaporation and changes in adhesive consistency occur much more rapidly than if the joint surfaces are in contact. Free exposure of the coated surfaces is called “open assembly;” surfaces in contact, “closed assembly.”

Proper adjustment of the assembly time is very important and often has significant effect on the quality of the glue joints. A too-short assembly period often results in “starved” glue joints, particularly with low-viscosity adhesives and dense species that absorb moisture from the glue slowly. Too long an assembly period (particularly open assembly) can easily result in “skinning” over or drying out of the glue film. The result is inadequate transfer of adhesive from the spread to the unspread surfaces.

PRESSING OR CLAMPING

Glue-joint surfaces must be brought into close contact to enable the adhesive to form a bond between them. Hence the application of adequate and uniformly distributed pressure to the joint at the proper time is essential in production of consistently high-quality bonded joints. Pressure must smooth the adhesive to a continuous, fairly thin layer between the wood surfaces, and hold the parts in close contact while the adhesive is setting or curing.

The optimum thickness of glue films in joints varies with the type of adhesive and wood species. Cured films as thin as 0.002 inch have resulted in good bonds with urea adhesives, and those as thick as 0.010 inch resulted in good quality joints with resorcinol adhesives used with dense species. For best results, pressure should be applied evenly over the entire joint area. Fluid pressure, such as used in bag molding with thin veneers, comes closest to being completely uniform.

In hot-pressing plywood, multi-opening hydraulic hot presses (fig. 43) apply pressure of about 175 pounds per square inch to the veneers while the glue is curing. In laminating, retaining clamps of various types (figs. 52, 87, and 88) are commonly used. Caul boards are laid

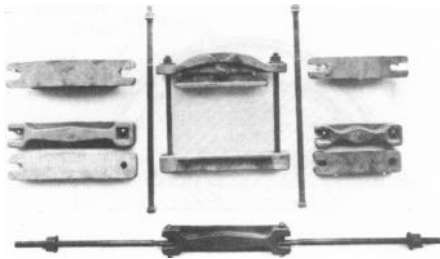

M 57292

Figure 87.— Double-bolt rockerhead clamps used to apply gluing pressure to laminated assemblies. The rockerhead equalizes the pressure across the assembly.

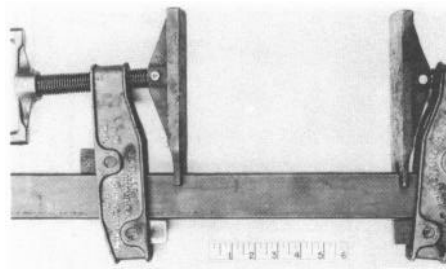

M 87206 F

Figure 88.— C-type rockerhead clamp with adjustable span used for laminating and other gluing pressure applications.

between the clamp and the glued assembly to distribute pressure to the areas between clamps. These cauls must be thick enough to distribute the pressure uniformly, as well as being flat and smooth. The clamps must be sufficiently close together to produce adequate pressure between as well as under the points of contact. Gluing pressure in the range of 100 to 200 pounds per square inch is usually adequate for most operations, with viscous adhesives and dense species generally requiring the top of the range.

When clamps are used to apply gluing pressure, torque wrenches and similar devices may be used to determine the amount of pressure applied. Figure 89 shows a panel press where pressure is applied by compressed air hoses.

Satisfactory gluing for certain constructions can also be accomplished with nail pressure, provided the nails are spaced and driven properly and the proper precautions are taken with regard to assembly time. The pressure obtained with nails is relatively low; hence the adhesive must be fairly fluid when the nails are driven.

No general rules have been developed for relating nail size and spacing to insure adequate pressure. The nailing pattern and spacing shown for the light plywood-lumber truss in figure 77, however, has given adequate glue-bond quality. The adhesive was a phenol-resorcinol.

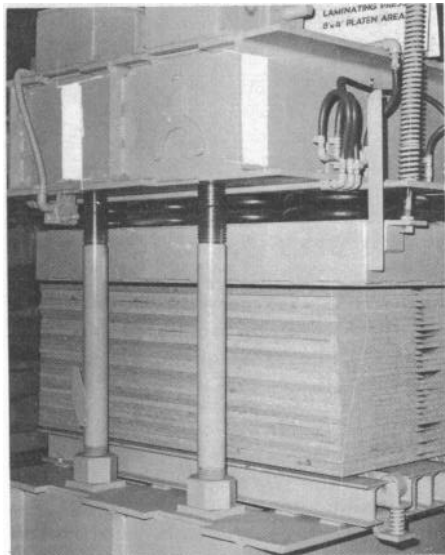

M 138 266-7

Figure 89.— Compressed air hose laminating press for cold pressing panels.

Bag-molded plywood for aircraft and light boats was produced during World War II and later. Recently, application of wood-grained vinyl film to irregularly

shaped articles such as wood carvings has come into use. Both vacuum molding and fluid pressure molding (fig. 90) are suitable for application of plastic films to upgrade wood surfaces.

CURING ADHESIVE

Curing requirements of adhesives commonly used for wood range from normal room temperatures to about 300° F. Some adhesives, such as the ureas, are formulated both for room-temperature and elevated-temperature curing. The hot-setting ureas generally cure in the range of 240° to 260° F. The melamines cure in about the same range but will also cure at lower temperatures with extended curing periods.

For assembly operations, adhesives such as polyvinyls, ureas, resorcinols, and animal glues are generally used at normal room temperatures. The thermosetting polyvinyls can be cured both at normal room temperatures and at elevated tem-

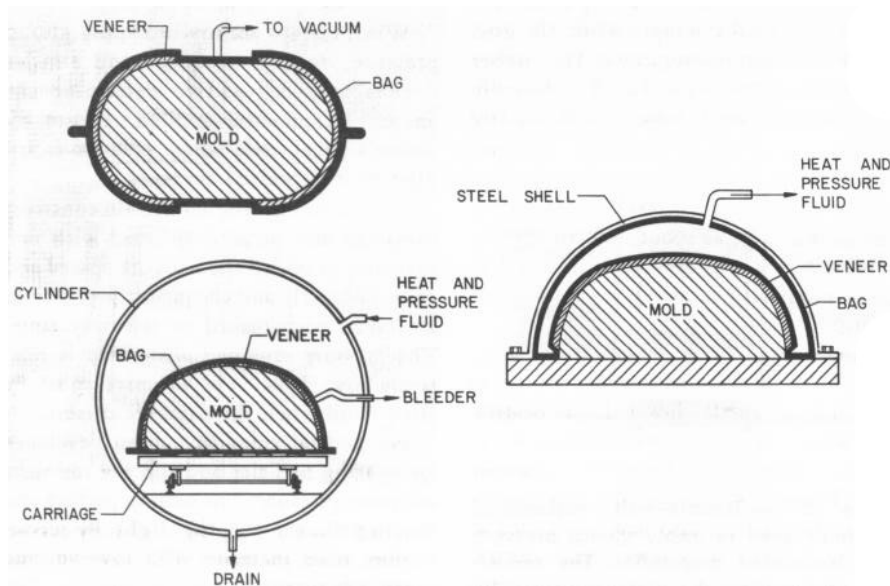

M 142395

Figure 90.— Three methods of forming bag-molded plywood.

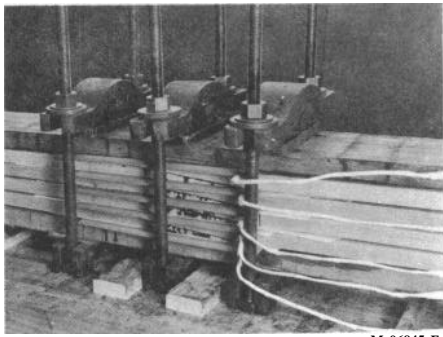

M 96845 F

Figure 91.— Curing glue in scarf joints with low-voltage electric heating. The heating elements are embedded in silicone rubber pads and aluminum foil separates the pads from the boards to prevent contamination of the pads by glue squeezeout.

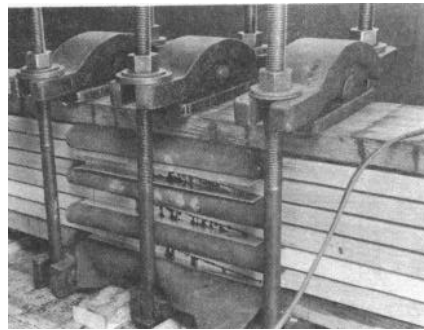

M 96844 F

Figure 92.— Curing phenol-resorcinol in scarf joints with continuous rubber pad heated with low-voltage electric current. Thin sheets of aluminum separate pad from boards to prevent contamination of pad by squeezed-out glue.

peratures, but provide more durable bonds when heat cured. Resorcinols provide durable bonds on many species when cured at room temperatures, but denser species such as oak require elevated temperatures to provide bonds as durable as the wood within a reasonable time period (fig. 11).

The rate of cure of resin adhesives depends both on the type of catalyst used and the curing temperature. The higher this temperature for a given glue, the more rapid is the curing reaction and the shorter the time required to complete the cure. Alkaline phenolic resins, the type used almost exclusively for exterior plywood, cure in the range of about 265° to 310° F. Acid-catalyzed phenols are formulated to set at temperatures as low as room temperature.

Curing equipment ranges from large, steam-heated hot presses for plywood (fig. 43) to small, low-voltage heating pads where resistance wire is embedded in silicone rubber (figs. 91 and 92) to generate heat. Thin wires or other conductive material in the glueline also have been used as heating elements with low-voltage electric current. Curing of a slightly curved lami-

nated member by low-voltage heating is illustrated in figure 93. This method requires a transformer and somewhat heavy leads.

Preheating wood before spreading and then using the stored heat to cure the adhe-



M 138 264-2

Figure 93.— Curing glue in slightly curved laminated member with low-voltage electric current.

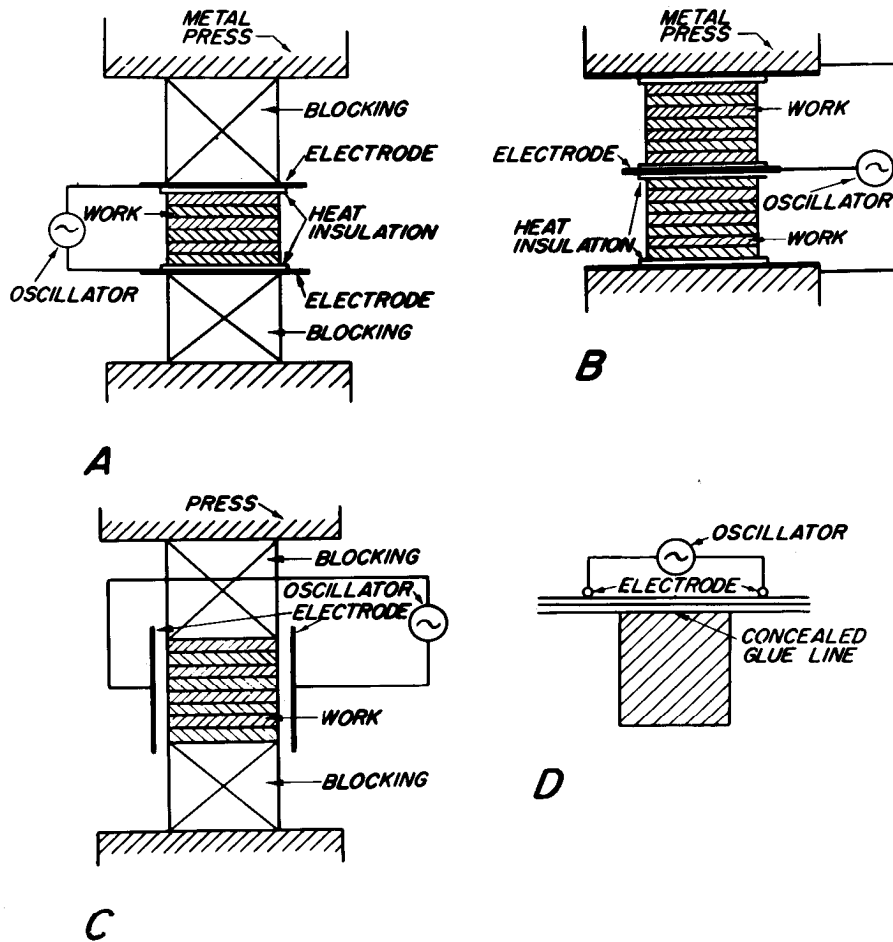

M 89990 F

Figure 94.— Various electrode arrangements for applying high-frequency electrical energy to glued assemblies. A, Assembly between electrodes, with electric field perpendicular to plane of glue joints; B, sandwich method, with high-voltage electrode between the two assemblies being glued; C, electrodes arranged for parallel or selective heating of glue joints; D, stray-field heating arrangements of electrodes.

sive is a technique sometimes used for special applications such as finger-jointing lumber and for laminating timber decking in a continuous process.

For large, laminated members, enclosures formed with canvas or other materials over the clamped assemblies (fig. 67) are supplied with heat from steam pipes or by other means for curing the glue.

Because wood is a good heat insulator, this process is somewhat time consuming.

High-frequency (H-F) heating (fig. 94) is probably the method most widely used for elevated-temperature curing the glue in members that do not lend themselves to hot pressing, particularly for smaller items such as furniture parts. H-F heating has been used extensively for such operations

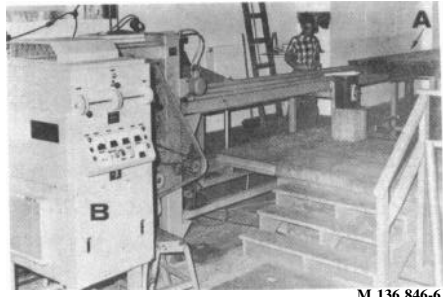

Figure 95.— Finger-jointed lumber, A, spread with glue traveling on a conveyor toward an H-F unit, B, for curing.

as edge gluing of lumber and curing glue in finger joints (figs. 95 and 96). It is also being used in Europe for laminating beams by continuous operation (fig. 97). Curing the glue in steps (each step equals the length of press) in laminated beams by H-F heating has been practiced by at least two laminators in the United States for a number of years.

The H-F curing cycle depends on such factors as generator capacity, type of glue and glue joint area, and the arrangement of the electrodes in relation to the glue joints. Parallel heating (fig. 94, C) is generally the most efficient method since the larger part of the energy is converted to heat in the gluelines. The level of moisture content in the wood is an important factor. The higher the moisture content the more conductive the wood becomes; thus, the more energy is dissipated throughout the wood instead of being concentrated at the glue joints.

Close control of the variables involved in the gluing operation is required for successful H-F curing. Accurate machining, uniform moisture content in the wood, and uniform glue spread are some of the more important factors. Technical knowledge in the generation and use of high-frequency currents is also of vital importance with this type of curing.

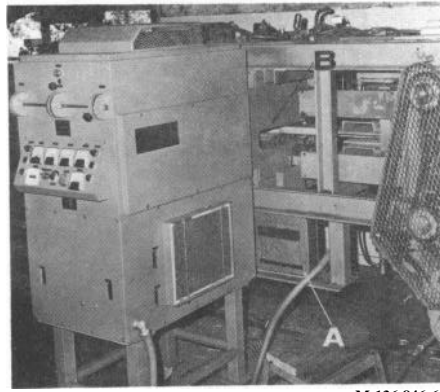

Figure 96.— Finger joints stopped by electronic memory system, A, between electrodes of high-frequency generator, B, indicates location of electrodes and the curing area.

In high-frequency curing, the resin adhesives for wood are generally rated from easiest to use to most difficult in this order: Ureas, melamine-ureas, thermosetting polyvinyls, melamines, resorcinols, phenol-resorcinols, and phenols.

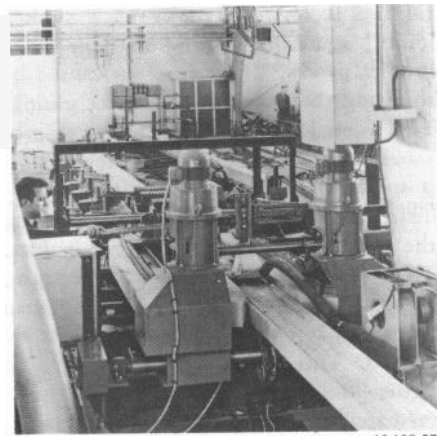

Figure 97.— High-frequency curing of adhesive in laminated beams by continuous process. Gluing pressure is applied in the electrode area by blocks fastened to belt moving along endless track. Parallel heating is employed and the upper electrode can be seen on top of the beam.

CONDITIONING GLUED PRODUCTS

It is usually not economical to maintain gluing pressure or continue curing under pressure until the adhesive joints have reached their ultimate strength. A conditioning period after gluing pressure has been released is beneficial in many ways. It allows moisture, if introduced by the glue, to diffuse away from the glue joints and equalize throughout the member. It permits the glue to continue to set and approach its ultimate bond strength. Stresses set up in the glued article during the gluing and curing operation will tend to be relieved and die out.

Because hot pressing generally lowers the moisture content of a panel and cold pressing increases the moisture content, conditioning panels and other products under controlled humidity and temperature is generally desirable and also most efficient.

A typical example of inadequate conditioning is represented by the "sunken joints" sometimes found in edge-glued lumber panels. They are often caused by surfacing the stock too soon after gluing. The wood adjacent to the joint absorbs water from the glue and swells. If the panel is surfaced before this excess moisture is distributed, more wood is removed along the joints than at intermediate points. Then during equalization of the moisture, greater shrinkage occurs at the joints than elsewhere, and permanent depressions are formed. This condition is illustrated in figure 98 where panels were surfaced immediately after gluing pressure was released. When improperly conditioned panels are veneered, showthrough of sunken joints and similar defects mars surface appearance.

Based on research at the Forest Products Laboratory, the following conditions maintained in a room with good circulation should provide reasonable assurance

that sunken joints will be minimized or eliminated in edge-glued panels:

7 days at 80° F. and 30 percent relative humidity

4 days at 120° F. and 35 percent relative humidity

24 hours at 160° F. and 44 percent relative humidity

16 hours at 200° F. and 55 percent relative humidity

These recommendations are based on the appearance of edge-glued panels with a high-gloss finish. With panels given a matte finish or panels covered with veneer, shorter conditioning periods generally would be sufficient. If there is an appreciable layover period between the surfacing and the sanding and finishing operations, the conditioning period can probably be somewhat shortened, since some surface irregularities are removed by the sanding.

For edge-glued furniture panels that are subsequently covered both with crossbands (usually one-sixteenth or one-twentieth inch) and face veneers (usually one twenty-eighth inch), it is expected that the conditioning times shown above could be appreciably shortened at the different temperatures, perhaps to as much as one-half the time indicated.

ADJUSTMENTS IN ADHESIVES AND GLUING PROCEDURES

The strength and quality of a glue joint depend not only on the type of wood or the quality of the glue used but also on the gluing procedure in making the joint. Often the same glue is entirely adequate for a wide range of species provided the gluing conditions are adjusted to the requirements of the particular species involved.

A specific example from production illustrates the type of adjustments that are required at times. White oak ship

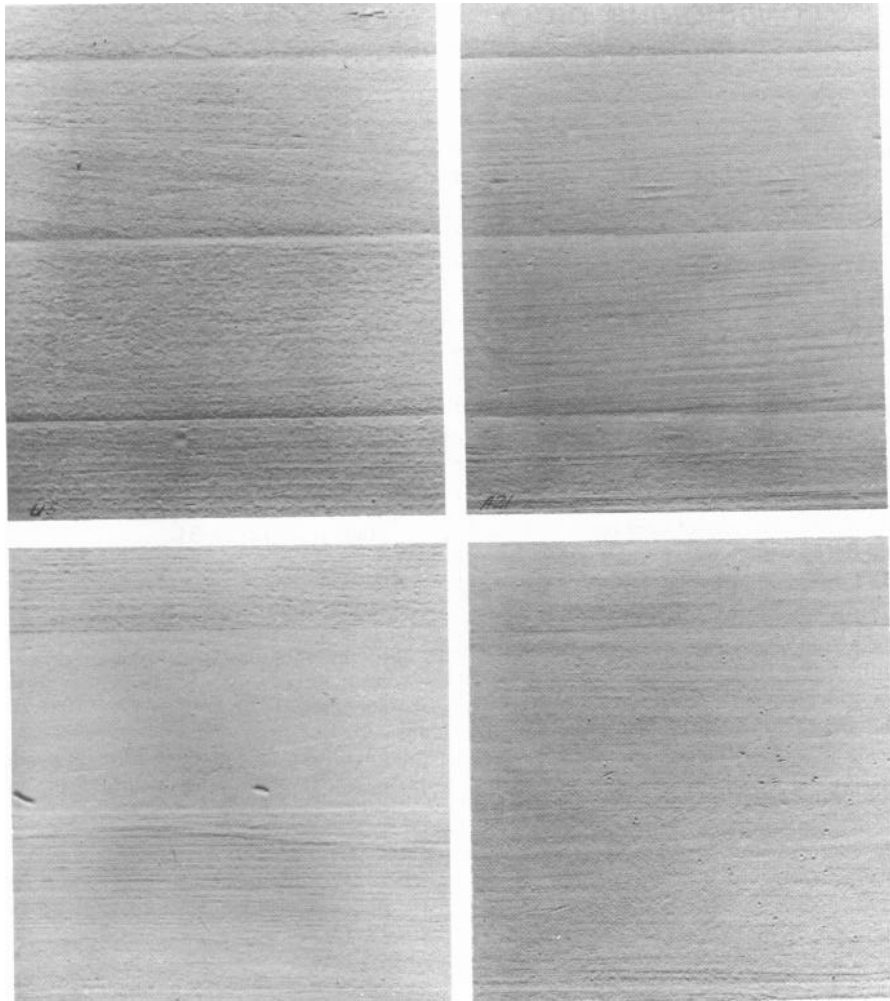

M 86081 F

Figure 98.— Yellow-poplar panels edge-glued with urea resin cured by high-frequency dielectric heating and with animal glue set at room temperature. Upper panels (left, urea; right, animal glue) were surfaced immediately after gluing pressure was released. Lower panels (left, urea; right, animal glue) were conditioned 7 days at room temperature before they were surfaced. Note sunken joints on panels surfaced without conditioning.

frames were laminated in a plant where the temperature generally exceeded 90° F. during summer days. The glue was freshly mixed shortly before spreading. The laminations were assembled and clamping pressure applied in rapid succession. The glue bonds were excellent. In another plant,

where the same adhesive was used to laminate similar frames, the temperature ranged from 60° to 70°F. To obtain acceptable glue bonds under these conditions, the mixed glue had to be aged at least half an hour before spreading and full gluing pressure was not applied for at least

2 hours after spreading. The longer closed assembly time was required (at the lower temperature) to allow the glue to penetrate the dense wood surface and reach the proper viscosity before applying full gluing pressure.

When bonding a dense wood, it appears that the glue must be viscous at the time pressure is applied on the joint. With a light, porous species much more latitude in glue viscosity is permissible. A light wood is generally more absorbent; hence, a starved joint condition (glue too thin at time of pressure application) is less apt to occur. Also, a lower gluing pressure usually can be employed than with dense species.

A good correlation has been noted between the viscosity of urea resin and bond durability in plywood made from sliced hard maple, with the higher viscosities giving the higher durability. The woodworker of years past touched the spread animal glue film with his fingertips; when the glue was sufficiently tacky to stick to the fingers and pull off the strings, he knew it was the proper time to bring the mating pieces together and apply gluing pressure.

SELECTED REFERENCES

- Adhesives Age
1964. Edge glue spreader with vertical axis application roll. *Adhes. Age* 7(9):29.
- Bellosillo, S. B.
1970. Nail-gluing of lumber-plywood assemblies-a literature review. Inf. Rep. OP-X-29. 70 p. Can. For. Serv., Dep. of Fisheries and Forest., Ottawa, Canada.
- Chow, S. Z., and Hancock, W. V.
1969. Method for determining degree of cure of phenolic resin. *For. Prod. J.* 19(4): 21-29.
- Currier, Raymond A.
1963. Compressibility and bond quality of western softwood veneers. *For. Prod. J.* 13(2):73-79.
- Freeman, Harlan G.
1970. Influence of production variables on quality of southern pine plywood. *For. Prod. J.* 20(12):28-31.
- Rayner, C. A. A.
1965. Cascade gluing in plywood manufacturing. *Adhes. Age* 8(2):33-35.
- Rice, J. T.
1965. Effect of urea-formaldehyde resin viscosity on plywood wood bond durability. *For. Prod. J.* 15(3):107-112.
- Selbo, M. L.
1952. Effectiveness of different conditioning schedules in reducing sunken joints in edge glued lumber panels. *For. Prod. J.* 2(1):110-112.
- Webb, David A.
1970. Wood laminating adhesive system for ribbon spreading. *For. Prod. J.* 20(4): 19-23.

GLUING TREATED WOOD

Production of laminated glued wood products suitable for unprotected exterior use dates back to the development of resorcinol and phenol-resorcinol adhesives about 1943. Glues available before that time either lacked necessary water resistance or required very high curing temperatures such as those used for exterior-type plywood.

The ability of resorcinol or phenol-resorcinol adhesives to provide a highly

durable bond at moderate temperatures made possible the production of large laminated timbers suitable for exterior use from the standpoint of the bonded joint. To impart durability to the wood under exterior service, however, preservative treatment is sometimes required. In some instances, the laminations are treated before gluing, and this necessitated development of procedures for bonding preservative-treated wood.



M 128 112

Figure 99.— Bridge on logging railroad near Longview, Wash., built with laminated stringers pressure treated with creosote-oil mixture before erection.

Preservative-treated structures can also be produced by treating the glued members, and numerous structures of this type have been built (fig. 99). Treatment of glued members permits application of preservative after all cutting, boring, and other framing has been done, to assure a protective coating on all exposed surfaces. Material handling at the treating plant is often simplified when the finished members, rather than the lumber, are treated. Probably the most serious disadvantage of this method is the limited size of treating cylinders, which precludes treatment of larger timbers and particularly of large curved ones. Preservative penetration is blocked by gluelines to some extent and this, of course, is a disadvantage. Further-

more, when only the outer layer of a member is treated, checks that sometimes develop later in service may allow decay to start. On the other hand, bridge timbers produced by this method (pressure-treated with creosote or creosote and oil mixtures after gluing) have been found to be in excellent condition after more than 25 years of service.

Wood pressure-treated with preservatives can be used to produce members of practically any size and shape that are thoroughly impregnated. By proper selection of materials, thin laminations can be given complete penetration with preservative chemicals; this as a rule is not possible with larger timbers. Laminated members produced from such treated stock can

be safely shaped and bored without exposing untreated material.

When a plant stocks treated lumber at the proper moisture content, it can usually fill an order for glued treated wood much more promptly than when the members must be laminated and then shipped to a treating plant.

Of the two methods, treatment after gluing has been most used. However, when laminated members do not lend themselves to treatment because of their size and shape, gluing treated material is the only known method to produce adequately treated members.

Studies on gluing of wood treated with wood preservatives and fire-retardant chemicals were undertaken during the latter part of World War II and years that

followed. This type of material was glued commercially as early as 1945 (fig. 100). Data show that certain combinations of glue and preservative treatments are compatible under prescribed conditions of gluing, whereas others require further study-both on laboratory and commercial scale-before definite production procedures can be formulated. The advice of the glue manufacturer should be sought before gluing wood treated with a particular preservative.

All combinations of preservatives and glues do not perform equally well and the conditions that lead to good, durable bonds on untreated wood do not always apply to treated wood.

Certain basic principles that apply to gluing untreated wood do hold true to a



M 124 523

Figure 100.—Laminated southern pine stringers in 60-foot, open-deck trestle on Atlantic Coastline Railroad south of Palmetto, Fla. Lumber used in stringers was treated with fluor-chrome-arsenate-phenol (Wolman salt) before gluing. The stringers on the opposite side of the trestle were glued from creosote-treated southern pine.

certain extent for gluing treated wood. For example, in gluing untreated wood there is usually considerable difference in the gluing properties of the different species—the denser woods in general requiring stronger adhesion to the wood and greater cohesive strength in the glue than the lighter ones. This also applies to treated wood, although bonding treated wood further depends on the concentration of preservative on the surface at the time of gluing and the chemical effect of the preservative on the glue.

In general, somewhat more curing (higher temperature or longer time) is required when gluing treated than untreated wood.

A reasonably clean joint surface is required in the bonding of untreated wood, and this appears to apply also to treated wood. There also seems to be fairly good evidence that, where gluing of treated lumber is involved, surfacing after treating (preferably shortly before gluing) is required. Where the glued members are intended to withstand exterior exposure, the joints should pass the tests prescribed in Voluntary Product Standard PS 56-73 for structural glued-laminated timber. Where the treatment is intended mainly for resistance to termites and similar hazards, and the glued members are protected from the weather, the tests prescribed for interior service of glue joints in laminated timbers might be sufficient.

WOOD TREATED WITH OIL-SOLUBLE PRESERVATIVES

Because wood treated with oil-soluble preservatives usually goes into exterior or similar types of service, only adhesives suitable for severe exposure conditions, such as resorcinol and phenol-resorcinols, should be used. As a general rule, woods that take treatment well, such as southern pine, can also be glued satisfactorily. Those difficult to treat are more problematic, and a “clean treatment” (by steaming or other means)

is required for satisfactory bonding. The type of solvent also affects gluability. Volatile solvents such as naphtha and mineral spirits cause less interference with bonding than heavier solvents such as fuel oil. Wood treated with pentachlorophenol in liquefied fuel gas is reported to cause practically no gluing problem.

WOOD TREATED WITH WATERBORNE PRESERVATIVES

When wood is treated with waterborne chemicals, the moisture content of the wood is appreciably increased and redrying is necessary. Upon being redried, the lumber generally is somewhat distorted, covered with deposits of chemicals to some extent, and too variable in thickness to be suitable for good gluing. Resurfacing becomes necessary. When the stock is resurfaced immediately before gluing, there appears to be, generally, less problem in gluing wood treated with waterborne preservatives than in gluing wood treated with oil-borne preservatives. Laminated bridge timbers glued from lumber treated with waterborne preservatives have given satisfactory service for about a quarter century.

Treating large laminated timbers with waterborne preservatives after gluing is generally not recommended because of checking and dimensional changes that occur during drying.

WOOD TREATED WITH FIRE-RETARDANT CHEMICALS

Because fire-retardant-treated wood is often used in relatively dry exposure for such purposes as veneered doors, wall panels, and partitions, adhesives only moderately resistant to moisture might occasionally be suitable. For maximum fire resistance (as far as the glue is concerned), it probably is necessary to use phenol,

resorcinol, and melamine resins that do not permit the wood to delaminate or separate when it is charred. Many fire-retardant salts are hygroscopic, and wood treated with them has higher equilibrium moisture content than untreated wood. This is another reason for using adhesives with high water resistance.

Fire-retardant formulas usually employ various chemicals in mixture so a desired combination of properties is obtained. It is therefore extremely difficult to provide general recommendations for gluing wood treated with such chemical mixtures. Wood treated with some widely used fire retardants has been glued successfully, however, using a high-formaldehyde-content resorcinol adhesive developed especially for the purpose. Before gluing fire-retardant-treated material, it is advisable to consult the treating company and the glue supplier or both for specific recommendations on the particular brand of adhesive to use.

SELECTED REFERENCES

- Bergin, E. G.
1963. Gluability of fire-retardant-treated wood. *For. Prod. J.* 13(12):549-556.
- Blew, J. O., and Olson, W. Z.
1950. The durability of birch plywood treated with wood preservatives and fire-retarding chemicals. *Proc. Am. Wood Preserv. Assoc.* 46:323-338.
- Selbo, M. L.
1959. Summary of information on gluing of treated wood. U.S. For. Prod. Lab. Rep. 1789. 21 p. U.S. Dep. Agric. For. Serv. For. Prod. Lab., Madison, Wis.
- Selbo, M. L.
1960. The gluing of treated wood. *Proc. Am. Wood Preserv. Assoc.* 56:70-73.
- Selbo, M. L.
1961. Effect of solvent on gluing of preservative-treated red oak, Douglas-fir, and southern yellow pine. *Proc. Am. Wood Preserv. Assoc.* 57:152, 163.
- Selbo, M. L., and Gronvold, O.
1958. Laminating of preservative-treated Scotch pine. *For. Prod. J.* 8(9):25A-26A.

QUALITY CONTROL

The author's first experience with evaluation of glue-joint quality was gained by splitting apart the edge and end trims of plywood panels as the panels came through trim saws. If the failures were mostly in the wood, it was a good indication that the samples would pass the more stringent and sophisticated laboratory tests, but if the failures were in the glue joints, there was a good chance they would not pass.

The purpose of mentioning such crude tests as ripping apart edge trims of plywood and prying apart laminations from the end trim of beams and arches with a chisel is to stress these points: (1) The sooner defective joints are detected, the sooner corrections can be made, and the less loss will be involved; (2) even a crude quality-control test is better than no test at all.

Up to recent years, shear block tests (ASTM D 905, Standard Method of Test for Strength Properties of Adhesive Bonds in Shear by Compression Loading) on hard maple were a common requirement in glue specifications. This test has merit in evaluating glues for furniture of maple and similar species, particularly if specimens are also subjected to high-low humidity cycling; however, its dependability is far from adequate to estimate the serviceability of glues on species such as oak in exterior service.

It is good practice to evaluate a glue on the species and under the bonding conditions that will be employed in production; it is also desirable to use test specimens somewhat similar in construction to the product. But inasmuch as the range in density and gluability is often appreciable

certain extent for gluing treated wood. For example, in gluing untreated wood there is usually considerable difference in the gluing properties of the different species—the denser woods in general requiring stronger adhesion to the wood and greater cohesive strength in the glue than the lighter ones. This also applies to treated wood, although bonding treated wood further depends on the concentration of preservative on the surface at the time of gluing and the chemical effect of the preservative on the glue.

In general, somewhat more curing (higher temperature or longer time) is required when gluing treated than untreated wood.

A reasonably clean joint surface is required in the bonding of untreated wood, and this appears to apply also to treated wood. There also seems to be fairly good evidence that, where gluing of treated lumber is involved, surfacing after treating (preferably shortly before gluing) is required. Where the glued members are intended to withstand exterior exposure, the joints should pass the tests prescribed in Voluntary Product Standard PS 56-73 for structural glued-laminated timber. Where the treatment is intended mainly for resistance to termites and similar hazards, and the glued members are protected from the weather, the tests prescribed for interior service of glue joints in laminated timbers might be sufficient.

WOOD TREATED WITH OIL-SOLUBLE PRESERVATIVES

Because wood treated with oil-soluble preservatives usually goes into exterior or similar types of service, only adhesives suitable for severe exposure conditions, such as resorcinol and phenol-resorcinols, should be used. As a general rule, woods that take treatment well, such as southern pine, can also be glued satisfactorily. Those difficult to treat are more problematic, and a “clean treatment” (by steaming or other means)

is required for satisfactory bonding. The type of solvent also affects gluability. Volatile solvents such as naphtha and mineral spirits cause less interference with bonding than heavier solvents such as fuel oil. Wood treated with pentachlorophenol in liquefied fuel gas is reported to cause practically no gluing problem.

WOOD TREATED WITH WATERBORNE PRESERVATIVES

When wood is treated with waterborne chemicals, the moisture content of the wood is appreciably increased and redrying is necessary. Upon being redried, the lumber generally is somewhat distorted, covered with deposits of chemicals to some extent, and too variable in thickness to be suitable for good gluing. Resurfacing becomes necessary. When the stock is resurfaced immediately before gluing, there appears to be, generally, less problem in gluing wood treated with waterborne preservatives than in gluing wood treated with oil-borne preservatives. Laminated bridge timbers glued from lumber treated with waterborne preservatives have given satisfactory service for about a quarter century.

Treating large laminated timbers with waterborne preservatives after gluing is generally not recommended because of checking and dimensional changes that occur during drying.

WOOD TREATED WITH FIRE-RETARDANT CHEMICALS

Because fire-retardant-treated wood is often used in relatively dry exposure for such purposes as veneered doors, wall panels, and partitions, adhesives only moderately resistant to moisture might occasionally be suitable. For maximum fire resistance (as far as the glue is concerned), it probably is necessary to use phenol,

within a species, as an added safety feature, the glue might also be evaluated on a denser species than the one to be used in production.

The well-worn phrase that dense wood is "more difficult to glue" does not necessarily mean that the same adhesive develops high wood failure in a light wood and low wood failure in a dense wood. The glue may not have been used under the optimum conditions required for the denser wood; or it may not be strong enough to cause failure in the denser material.

As in any manufacturing operation, control of quality of glue joints is extremely important, particularly since the raw materials—wood and glue—are characteristically somewhat variable.

The person in charge of quality control must be very knowledgeable, both in wood technology and in the physical and chemical characteristics of adhesives. There are product standards, industry standards, commercial standards, ASTM standards, Federal specifications, and military specifications that generally specify minimum performance requirements under different tests, and the procedures for carrying out the tests are fairly routine. But the interpretation of the test results, including the visual examination of the test specimens, often requires a great deal of knowledge and experience to determine their meaning and consider improvements or changes.

Needless to say, quality control does not involve only tests and evaluations of the

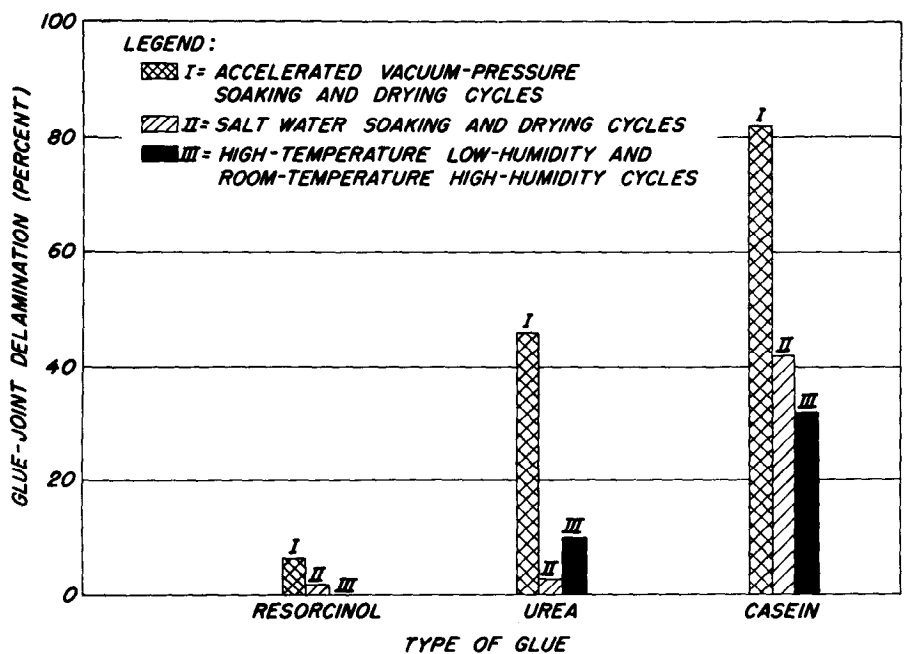

ZM 73979 F

Figure 101.— Effect of three types of accelerated laboratory tests on glue bonds in plywood-to-lumber gusset joints made with three types of adhesives. The vacuum-pressure, soak-dry cycles resulted in the largest amount of joint separation with each type of glue. The data indicate that two of the glues are unsuitable for severe exposures.

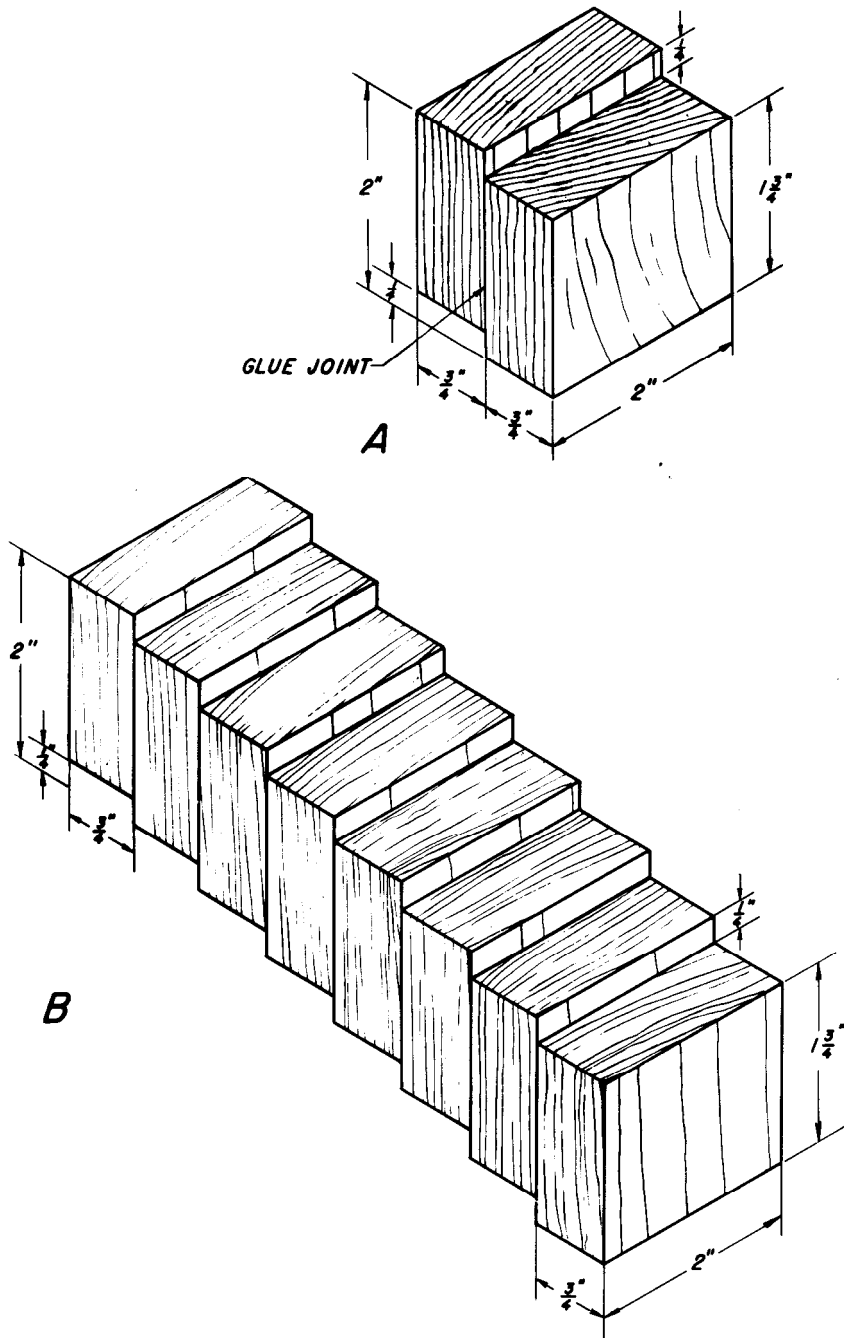

ZM 69813 F

Figure 102.— Standard block, A, and stair-step type, B, shear specimens for evaluating glue-joint strength and quality. The stair-step is convenient for testing successive joints in a laminated timber.

final products, but must begin with each ingredient that goes into the glued product.

This is particularly important where a number of wood species are used and a variety of products are made. The adhesive used for one species may not necessarily be adequate for another, or at least might require modification in the gluing procedure. Also, modifications might be required when changing from one product to another.

The standards and specifications for the different products generally specify one, and more often several, test requirements that a product must meet.

Although test methods must be used that will result in accelerated degradation of glue joints that would eventually fail under normal service conditions, the tests must be reasonable for the type of bond involved. Even the very best casein-glued joint, for instance, will fail after a few cycles of vacuum-pressure, soaking, and drying. Casein glue is not capable of forming exterior-type bonds; hence, test methods designed for such bonds are not applicable to casein-glued joints. Effects of three different accelerated test methods on three types of glue bonds in gusset-

type assembly joints are illustrated in figure 101.

Tests such as the compression block shear (figs. 102 and 103) and the plywood tension shear (figs. 104 and 105) have been employed to evaluate glue joints for decades. They give a good indication of initial quality and workmanship in producing the joints when tested dry. For determination of long-term durability, harsher treatments are required, and two 4-hour boil cycles interspersed with 20 hours of drying of the specimens (generally referred to as the boil test) has been the most widely used test for exterior plywood. Detailed procedures for this and other tests are given in many standards and specifications for plywood and adhesives.

Vacuum-pressure, soak-dry tests similar to ASTM 2559 have been used for about 3 decades to evaluate glue bonds in laminated construction (fig. 106) and have

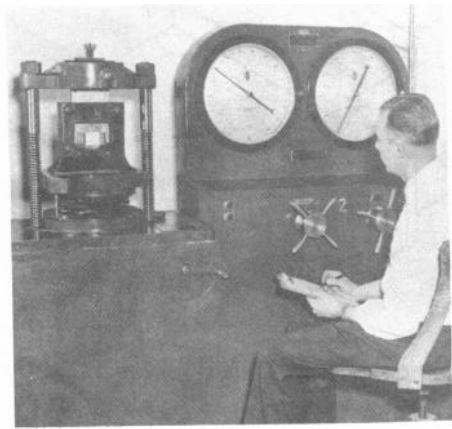

M 76703

Figure 103.— Block-shear testing of glue joints in universal testing machine.

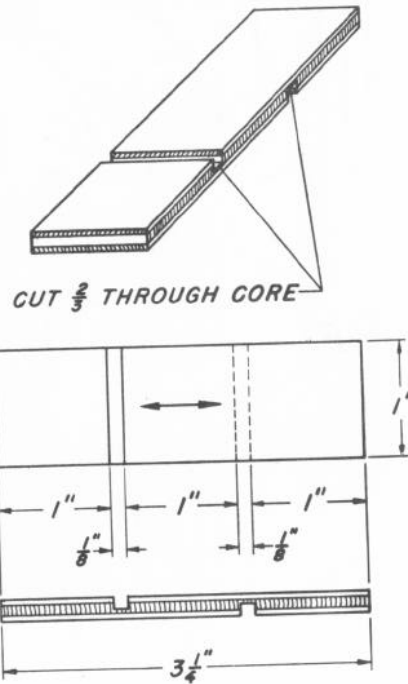
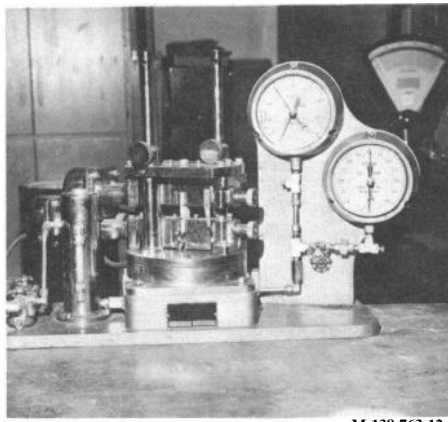

Figure 104.— Tension-shear specimen from three-ply plywood.



M 138 763-12

Figure 105.—Hydraulically operated, quick acting, tension-shear test machine for plywood.

within recent years also been adopted for plywood and particleboard. They are more indicative of weatherability and soak-dry resistance of glue joints and are also less time consuming than soaking and drying at atmospheric pressure.

Tension tests are generally considered the most reliable for glued end joints. A rectangular specimen shown in figure 107 is easily prepared and rapidly tested, important features in quality control.

Figure 108 illustrates an electronic universal testing machine capable of plotting stress-strain curves and suitable for use in compression and tension testing of a wide range of specimen types.

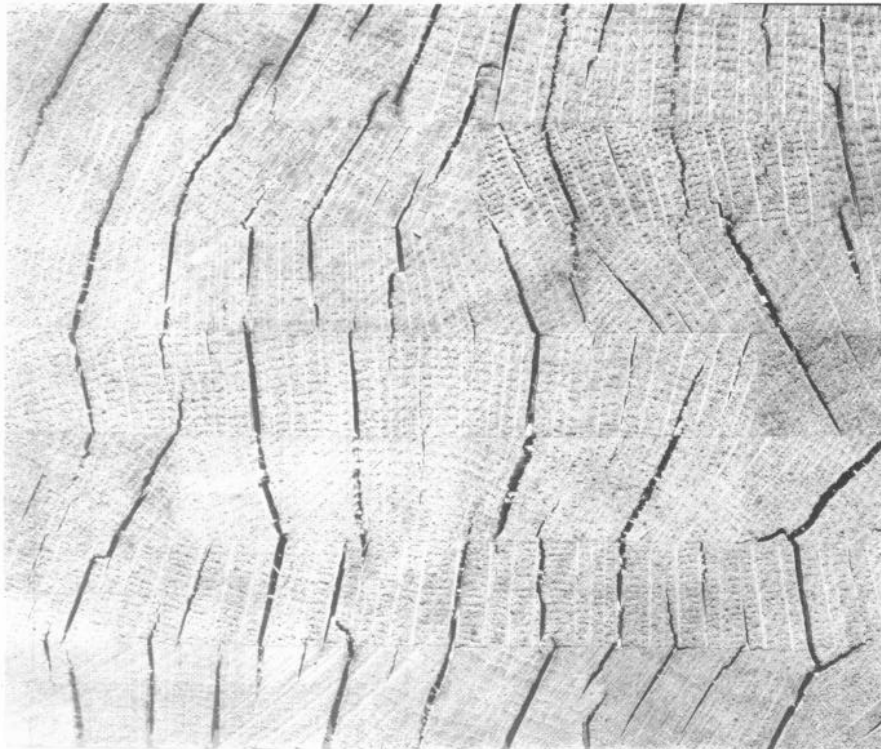

M 59284 F

Figure 106.—Laminated oak beam section after completion of vacuum-pressure, soak-dry cycles (ASTM D 2559). Glue joints are still intact although wood is badly checked from severe drying stresses inflicted by the test.

SELECTED REFERENCES

- American Institute of Timber Construction
Standard specifications for structural glued laminated timber of Douglas-fir, western larch, and California redwood. AIRC 203 (see current edition). Englewood, Colo.
- American Society for Testing and Materials
Standard specification for adhesives for structural laminated wood products for use under exterior (wet use) exposure conditions. ASTM D 2559 (see current edition). Philadelphia.
- American Society for Testing and Materials
Standard method of test for strength properties of adhesive bonds in shear by compression loading. ASTM D 905 (see current edition). Philadelphia.
- Callahan, Richard C.
1953. Quality control in furniture manufacture. *For. Prod. J.* 3(5):19-24.
- Kreibich, R. E., and Freeman, H. G.
1968. Development and design of an accelerated boil machine. *For. Prod. J.* 18(12): 24-26.
- National Woodwork Manufacturers Association
1969. Industry Standard I.S. 1-69. Wood flush doors; hardwood veneered including hardboard and plastic faced flush doors. July.
- Ripley, Robert M.
1953. Effective quality control on end product. *For. Prod. J.* 3(5):25-28. Dec.
- Selbo, M. L.
1962. A new method for testing glue joints of laminated timbers in service. *For. Prod. J.* 12(2):65-67.
- Selbo, M. L.
1964. Rapid evaluation of glue joints in laminated timber. *For. Prod. J.* 14(8): 361-365.
- Selbo, M. L.
1964. Tests for quality of glue bonds in end-jointed lumber. ASTM Special Tech. Publ. No. 353: 1962 Symposium on Timber, pp. 78-86. Am. Soc. Test. Mater. Philadelphia.
- U.S. Department of Commerce
Proposed Product Standard for hardwood and decorative plywood. PS 51 (see most recent issue).
- U.S. Department of Commerce
Softwood plywood construction and industrial. U.S. Prod. Stand. PS 1 (see latest edition).
- U.S. Department of Commerce
Structural glued laminated timber. Commer. Stand. CS 253 (see latest edition).
- U.S. Department of Commerce
Wood double-hung window units. Commer. Stand. CS 190 (see latest edition).

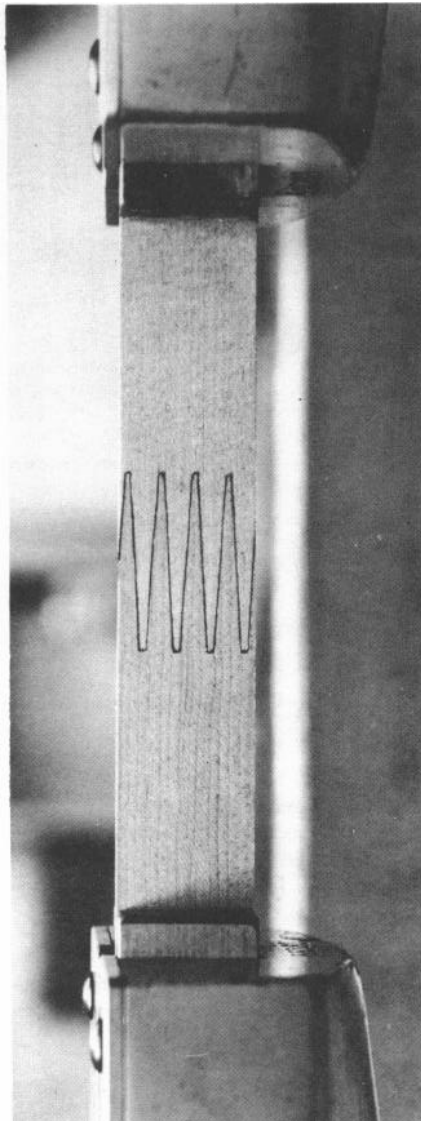

M 101 231

Figure 107.— Finger-jointed strip-tension specimen in test grips for testing.

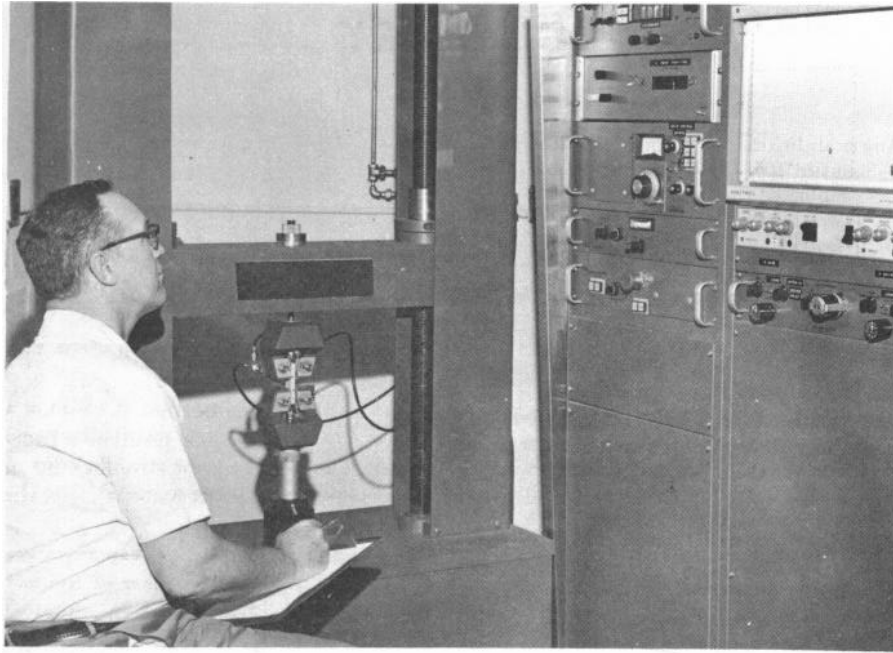

M 138 766-11

Figure 108.— Electronic universal testing machine capable of plotting stress-strain curves.

- U.S. Department of Defense
Adhesive; phenol and resorcinol resin base (for marine use only). Mil. Specif. MIL-A-22397. Def. Supply Agency (see latest edition).
- U.S. Department of Defense
Adhesive; modified epoxy resin with polyamine curing agent. Mil. Specif. MIL-A-81253(1). Def. Supply Agency (see latest edition).
- U.S. Department of Defense
Adhesive; epoxy resin with polyamide curing agent. Mil. Specif. MIL-A-81235(2). Def. Supply Agency (see latest edition).
- U.S. General Services Administration
Adhesive; urea resin type (liquid and powder). Fed. Specif. MMM-A-188b. Fed. Supply Serv. (see latest edition).
- U.S. General Services Administration
Adhesive; contact. Fed. Specif. MMM-A-130a. Fed. Supply Serv. (see latest edition).
- U.S. General Services Administration
Adhesive; animal glue. Fed. Specif. MMM-A-100c. Fed. Supply Serv. (see latest edition).
- U.S. General Services Administration
Adhesive; vinyl acetate resin emulsion. Fed. Specif. MMM-A-193c. Fed. Supply Serv. (see latest edition).
- U.S. General Services Administration
Adhesive; natural or synthetic-natural rubber. Fed. Specif. MMM-A-139. Fed. Supply Serv. (see latest edition).
- U.S. General Services Administration
Adhesive; synthetic, epoxy resin base, paste form, general purpose. Fed. Specif. MMM-A-187a. Fed. Supply Serv. (see latest edition).
- West Coast Adhesive Manufacturers Association's Technical Committee
1966. A proposed new test for accelerated aging of phenolic resin bonded particleboard. For. Prod. J. 16(6): 19-23.
- West Coast Adhesive Manufacturers Association
1970. Accelerated aging of phenolic resin bonded particleboard. For. Prod. J. 20(10):26-27.

GLOSSARY

- Absorptiveness.**—The ability of a solid to absorb a liquid or vapor, or the rate at which the liquid or vapor is absorbed.
- Aged (Matured).**—The condition at which the reaction between the active ingredients of an adhesive has reached the proper stage for spreading.
- Air seasoning (Air drying).**—The process of drying green lumber or other wood products by exposure to prevailing atmospheric conditions outdoors or in an unheated shed.
- Annual ring.**—The growth layer put on a tree in a single growth year, including earlywood and latewood.
- Architecturalplywood.**—Plywood having esthetic appeal, attractive grain pattern.
- Assembly joints.**—Joints for bonding variously shaped parts such as in wood furniture (as opposed to joints in plywood and laminates that are all quite similar).
- Assembly time.**—Interval between spreading the adhesive on the surfaces to be joined and the application of pressure to the joint or joints.
- Note—For assemblies involving multiple layers or parts, the assembly time begins with the spreading of the adhesive on the first adherend.
- (1) Open assembly time is the time interval between the spreading of the adhesive on the adherend and the completion of assembly of the parts for bonding.
- (2) Closed assembly time is the time interval between completion of assembly of the parts for bonding and the application of pressure to the assembly.
- Bacteria.**—One-celled micro-organisms which have no chlorophyll and multiply by simple division.
- Bag molding.**—A method of molding or bonding involving the application of fluid or pressure, usually by means of air, steam, water, or vacuum, to a flexible cover which, sometimes in conjunction with a rigid die, completely encloses the material to be bonded.
- Baseboard.**—A board placed against the wall around a room next to the floor to finish properly between floor and plaster or gypsum board.
- Blade-coating**—Application of a film of a liquid material (liquid resin) on a panel surface by scraping the straight edge of a steel blade, or other material, over the panel.
- Blistering.**—Formation of vapor pocket in a plywood panel because of too wet veneer, too much solvent in adhesive, too high adhesive spread, or too high cure temperature for the adhesive used.
- Blood albumin.**—Complex protinaceous material obtained from blood.
- Boilproof adhesive**—Adhesive that will not fail after many hours of boiling.
- Bond failure.**—Rupture of adhesive bond.
- Book matching.**—Matching veneer by turning over alternate sheets.
- Boom.**—A spar extending from a mast to hold bottom of sail outstretched; also used for loading and unloading purposes.
- Bowing.**—Distortion whereby the faces of a wood product become concave or convex along the grain.
- Burnished.**—A glazed surface with which it may be difficult to obtain a satisfactory bond.
- Burl.**—Burls come from a warty growth generally caused by some injury to the growing layer just under the bark. This injury, perhaps due to insects or bacteria, causes the growing cells to divide abnormally, creating excess wood, that finds room for itself in many little humps. Succeeding growth follows these contours. Cutting across

- these humps by the half-round method brings them out as little swirl knots or eyes.
- Butt joint.**—An end joint formed by gluing together the squared ends of two pieces. Because of the inadequacy and variability in strength of butt joints when glued, such joints are generally not depended on for strength.
- Calking gun.**—Device for dispensing a bead of calking material, mastic glue, etc.
- Capillary structure.**—An inclusive term for wood fibers, vessels, and other elements of diverse structure making up the material wood.
- Casehardening.**—A stressed condition in a board or timber characterized by compression in the outer layers accompanied by tension in the center or core, the result of too severe drying conditions.
- Catalyst.**—A substance that markedly speeds up a chemical reaction such as the cure of an adhesive when added in minor quantity as compared to the amounts of the primary reactants.
- Cell wall.**—Enclosing membrane for the minute units of wood structure.
- Cereal flour.**—Flour from grain used as food.
- Char.**—To scorch or reduce to charcoal by burning.
- Checking.**—A lengthwise separation of the wood that usually extends across the rings of annual growth and commonly results from stresses set up in wood during seasoning.
- Chemical synthesis.**—The formation of a complex chemical compound by combining two or more simpler compounds, radicals, or elements.
- Condensation reaction.**—A chemical reaction in which two or more molecules combine with the separation of water or some other simple substance. If a polymer is formed, the process is called polycondensation.
- Continuous feed press.**—Press in which panels are moving ahead (under pressure) while glue is setting.
- Convex.**—Curved like a section of the outside of a sphere.
- Copolymer.**—Substance obtained when two or more monomers polymerize.
- Clamping pressure.**—Pressure developed by clamps of various designs to bring joint surfaces into close contact for glue bond formation.
- Cleavage.**—Splitting or dividing along the grain.
- Closed side.**—Side of veneer not touching knife as it is peeled from log (also called tight side of veneer).
- Coagulation.**—The process by which a liquid becomes a soft, semisolid mass.
- Cohesion.**—The state in which the particles of a single substance are held together by primary or secondary valence forces. As used in the adhesive field, the state in which the particles of the adhesive (or the adherend) are held together.
- Cold flow.**—Tendency to yield or “flow” under stress at normal room temperature (see also Creep).
- Cold pressing.**—Pressing panels or laminates without application of heat for curing the glue.
- Compressometer.**—Device used for measuring pressure. Consists essentially of a cylinder, piston, and a pressure gage. Oil in the cylinder transmits the pressure applied to the piston to the gage.
- Compression wood.**—Abnormal wood formed on the lower side of branches and inclined trunks of softwood trees. Compression wood is identified by its relatively wide annual rings, usually eccentric, relatively large amount of earlywood, sometimes more than 50 percent of the width of the annual rings in which it occurs, and its lack of demarcation between earlywood and latewood in the same annual rings. Compression wood shrinks excessively lengthwise, as compared with normal wood.
- Concave.**—Curved like a section of the inside of a sphere.

- Co-spray dried.**—Dried by spraying two resins simultaneously into the same drying chamber from atomizing nozzles. (See also *Spray dried.*)
- Creep.**—The dimensional change with time of a material under load, following the initial instantaneous elastic or rapid deformation. Creep at room temperature is sometimes called cold flow.
- Creosote.**—Oily liquid used, among other things, as preservative for wood.
- Critical exposure.**—Exposure to harsh conditions (see also Severe exposure.).
- Cross grain.**—A general term for any grain deviating considerably from the longitudinal axis of a piece of timber and emerging at an angle from a face or edge.
- Cross-link.**—An atom or group connecting parallel chains in a complex molecule.
- Crotch veneer.**—Veneer cut from fork of tree to provide pleasing grain, figure, and contrast.
- Cup.**—Distortion whereby a board becomes concave or convex across the grain.
- Curing (Cure).**—To change the physical properties of an adhesive by chemical reaction, which may be condensation, polymerization, or vulcanization; usually accomplished by the action of heat and catalyst, alone or in a combination, with or without pressure.
- Curtain coating.**—Applying adhesive to wood by passing the wood under a thin falling curtain of liquid.
- Dado.**—A rectangular groove across the width of a board or plank.
- Delamination.**—The separation of layers in laminated wood or plywood because of failure of the adhesive, either in the adhesive itself or at the interface between the adhesive and the adherend.
- Density.**—Weight per unit volume, generally expressed in pounds per cubic foot. For wood, since changes in moisture content affect its weight and volume, it is necessary to specify the moisture condition of the wood at the time weight and volume are determined.
- Design criteria.**—Standard rules for design.
- Diagonal-grain wood.**—A form of cross grain where the longitudinal elements run obliquely but parallel to the surface; i.e., the growth layers are not parallel to the edge of the piece as viewed on a quartersawed surface.
- Doctor roll.**—Smooth roll whose position in relation to spreader roll is adjustable for regulating amount of glue spread.
- Door skins.**—Thin plywood, usually three-ply, used for faces of flush doors.
- Double spreading.**—Applying adhesive to both mating surfaces of a joint.
- Dovetail.**—Joint shaped like a dove's tail.
- Dowel.**—Wood peg fitted into corresponding holes in two pieces to fasten them together.
- Earlywood.**—The portion of the annual growth ring formed during the early growth period. Earlywood is less dense and mechanically weaker than latewood.
- Edge gluing.**—Bonding veneers or boards edge to edge with glue.
- Elasticity.**—The capacity of bodies to return to their original shape, dimensions, or positions on the removal of a deforming force.
- Elastomer.**—A material that at room temperature can be stretched repeatedly to at least twice its original length and, upon immediate release of the stress, will return with force to its approximate original length.
- Electrodes.**—In radiofrequency heating, metal plates or other devices for applying the electric field to the material being heated.
- Elevated temperature setting.**—An adhesive that requires a temperature at or above 31° C. (87° F.) to set (see also *Room temperature setting*).
- Emulsion.**—A mixture in which very small droplets of one liquid are suspended in another liquid.

- End grain.**—The grain of a cross section of a tree, or the surface of such a section.
- End joint.**—A joint made by gluing two pieces of wood end to end, commonly by a scarf or finger joint.
- Equilibrium moisture content.**—The moisture content at which wood neither gains nor loses moisture when surrounded by air at a given relative humidity and temperature.
- Expeller.**—Device that removes oil from bean by crushing (*See also Roller mill*).
- Extender.**—A substance, generally having some adhesive action, added to an adhesive to reduce the amount of the primary binder required per unit area.
- Exterior service.**—Service or use in the open (exposed to weather).
- External load.**—Load applied externally.
- External stresses.**—Stresses imposed by external load.
- Extractives.**—Any substance in wood, not an integral part of the cellular structure, that can be removed by solution in hot or cold water, ether, benzene, or other solvents that do not react chemically with wood components.
- Extrusion spreading.**—Adhesive forced through small openings in spreader head (*see also Ribbon spreading*).
- Exudation products.**—Tars and similar products that migrate to the wood surface.
- Fiber saturation point.**—The stage in the drying or wetting of wood at which the cell walls are saturated with water and the cell cavities are free of water. Also described as the moisture level above which no dimensional changes take place in wood. It is usually taken as about 30 percent moisture content, based on the weight when oven-dry.
- Figured veneer.**—General term for decorative veneer such as from crotches, burls, and stumps.
- Filler.**—A relatively nonadhesive substance added to an adhesive to improve its working properties, permanence, strength, or other qualities.
- Film adhesive.**—Describes a class of adhesives furnished in dry film form with or without reinforcing tissuelike paper or fabric.
- Finger joint.**—An end joint made up of several meshing fingers of wood bonded together with an adhesive.
- Fire retardant.**—A chemical or preparation of chemicals used to reduce flammability or to retard spread of fire.
- Flat-grained lumber.**—Lumber that has been sawed in a plane approximately perpendicular to a radius of the log. Lumber is considered flat grained when the annual growth rings make an angle of less than 45° with the surface of the piece.
- Flow.**—In gluing, the state of a substance sufficiently liquid to penetrate pores and minute crevasses when pressure is applied.
- Fluid pressure.**—Pressure applied by an inflated bag or similar means.
- Flush panels.**—Flat panels as on a flush door (no contorted or shaped parts).
- Fortifier.**—Material improving certain qualities in adhesives, such as water resistance and durability.
- Fungi.**—Simple forms of nongreen plants consisting mostly of microscopic threads (hyphae) some of which may attack wood, dissolving and absorbing substrate materials (cell walls, cell contents, resins, glues, etc.) which the fungi use as food.
- Gap-filling adhesive.**—Adhesive suitable for use where the surfaces to be joined may not be in close or continuous contact owing either to the impossibility of applying adequate pressure or to slight inaccuracies in matching mating surfaces.
- Glazed.**—Worn shiny by rubbing.
- Glossy finish.**—Shiny finish, reflects light.
- Gluability.**—Term indicating ease or difficulty in bonding a material with adhesive.

- Glue laminating.**—Production of structural or nonstructural wood members by bonding two or more layers of wood together with adhesive.
- Glueline.**—The layer of adhesive affecting union (bond) between any two adjoining wood pieces or layers in an assembly.
- Glue wheel.**—Continuous, caterpillar-type device or machine used for edge gluing panels or laminating small items such as table legs.
- Gluing pressure.**—Pressure to bring the surfaces spread with glue into close contact for bonding.
- Grain direction.**—Fiber direction (essentially parallel to pith of tree).
- Gravity feed.**—Moves ahead by virtue of its own weight.
- Gusset.**—A flat piece of wood, plywood, or similar type member used to provide a connection at the intersection of wood members. Most commonly used at joints of wood trusses. They are fastened by nails, screws, bolts, or adhesives or with adhesive in combination with nails, screws, or bolts.
- Hammermill.**—Consists of horizontal or vertical shaft rotating at high speed on which crushing elements, hammers, bars, or rings, are mounted.
- Hardener.**—A substance or mixture of substances added to an adhesive to promote or control the curing reaction by taking part in it. The term is also used to designate a substance added to control the degree of hardness of the cured film.
- Hardwood.**—A conventional term for the timber of broad-leaved trees, and the trees themselves, belonging to the botanical group Angiospermae.
- Heartwood.**—The wood extending from the pith to the sapwood, the cells of which no longer participate in the life processes of the tree. Heartwood may be infiltrated with gums, resins, and other materials that usually make it darker and more decay resistant than sapwood.
- High-frequency curing.**—Setting or curing adhesive with high-frequency electric currents.
- Hollow-core construction.**—A panel construction with facings of plywood, hardboard, or similar material bonded to a framed core assembly of wood lattice, paperboard rings, or the like, which support the facing at spaced intervals.
- Honeycomb core.**—A construction of thin sheet material, such as resin impregnated paper or fabric, which has been corrugated and bonded, each sheet in opposite phase to the phases of adjacent sheets, to form a core material whose cross section is a series of mutually continuous cells similar to natural honeycomb.
- Honeycombing.**—Fissures in the interior of a piece of wood generally caused by drying stresses resulting from case-hardening.
- Hot press.**—A press in which the platens are heated to a prescribed temperature by steam, electricity, or hot water.
- Humidity cycling.**—Exposure to high humidity followed by low humidity (or vice versa) for various periods.
- Hygroscopic.**—Term used to describe a substance, such as wood, that absorbs and loses moisture readily.
- Incident lighting.**—Light rays falling on a surface at a low angle or almost parallel to the surface.
- Interior service.**—Used in the interior (of a building) protected from outdoor weather.
- Internal stress.**—Stresses set up from internal conditions, such as differential shrinkage, aside from external loads applied to a member.
- Inverse proportion.**—A relation between variables in which one increases as the other decreases.
- Jacketed mixer.**—Double-wall mixer permitting cooling or heating liquid to circulate between the walls.
- Jig.**—A device for holding an assembly in place during gluing or machining operations.

- Jointer.**—Machine equipped with rotary cutter and flat bed permitting surfacing one side of a member at a time.
- Joint geometry.**—Shape or design of joint (for example, a finger joint).
- Joist.**—One of a series of parallel beams, usually nominally 2 inches thick, used to support floor and ceiling loads, and supported in turn by larger beams, girders, or bearing walls.
- Keel.**—The chief timber or steel member extending along the entire length of the bottom of a boat or ship to which the frames are attached.
- Kiln drying.**—The process of drying wood products in a closed chamber in which the temperature and relative humidity of the circulated air can be controlled.
- Lacquer.**—A clear finishing material consisting of shellac or gum resins dissolved in alcohol and other quick-drying solvents, with or without nitrocellulose.
- Laminated member.**—A wood member glued up from smaller pieces of wood, either in straight or curved form, with the grain of all pieces essentially parallel to the length of the member.
- Laminated timber.**—Synonymous to laminated member, but usually implies structural member.
- Latewood.**—The denser, smaller celled part of the growth layer formed late in the growing season.
- Layup.**—Assembled parts placed in position they occupy in final product.
- Lignin.**—The noncarbohydrate, structural constituent of wood and some other plant tissues, which encrusts the cell walls and cements the cells together; now believed to consist of a group of closely related polymers of certain phenylpropane derivatives.
- Low-voltage beating.**—Heating by passing low-voltage electric current through resistance elements.
- Marine plywood.**—Plywood made of veneers of grades specified for marine use and bonded with waterproof adhesive (usually phenolic type).
- Mastic adhesive.**—A substance with adhesive properties, generally used in relatively thick layers that can be readily formed with a trowel or spatula.
- Matte finish.**—Dull finish.
- Mature.**—(see *Aged*).
- Mechanical adhesion.**—Adhesion effected by the interlocking action of an adhesive that solidifies within the cavities of the adherend.
- Mechanical fasteners.**—Nails, screws, bolts, and similar items.
- Mesh sieve.**—The size of openings in a sieve as designated by the number of meshes (openings) per linear inch.
- Mitered joint.**—Joint cut at a 45° angle with fiber direction.
- Mixed grain.**—Mixture of flat-sawn and quartersawn pieces.
- Mold.**—A fungus growth on wood products at or near the surface and, therefore, not typically resulting in deep discolorations. Mold discolorations are usually ash green to deep green, although black is common.
- Molding.**—Shaping or forming to desired pattern or form.
- Monomer.**—A relatively simple compound which can react to form a polymer.
- Mortise.**—A slot cut in a board, plank, or timber, usually edgewise, to receive tenon of another board, plank, or timber to form a joint.
- Multiopening press.**—Press having a number of platens between which panels can be pressed.
- Nailed glued.**—A laminate for which gluing pressure is obtained by nailing together the pieces spread with glue.
- Nail popping.**—Protrusion of nailheads because of shrinking and swelling of wood.
- Natural adhesive.**—Adhesive produced from naturally occurring products such as blood and casein.
- Neoprene.**—Synthetic rubber.
- Nominal lumber.**—The rough-sawed commercial size by which lumber is

- known and sold in the market; for example, a 2 by 4.
- Nonvolatile.**—Portion of a solution that is not easily vaporized.
- Oil-borne preservative.**—Preservative dispersed or dissolved in oil carrier or vehicle.
- Oil-soluble preservative.**—Preservative chemical dissolved in oil carrier.
- Open assembly.**—The time interval between the spreading of the adhesive on the adherend and the completion of assembly of the parts for bonding. (See also *Assembly time.*)
- Open piling.**—Stacking wood products layer by layer, separated by strips of wood inserted between layers to permit air circulation.
- Open side.**—Side of veneer next to knife as it comes off the log (also called loose side).
- Organic solvents.**—Solvents based on carbon compounds.
- Original dry strength.**—Shear strength developed by glue joints when tested dry and before aging or exposure to deteriorating conditions.
- Overhang.**—Part of roof extending beyond the outer wall.
- Overlay.**—Plastic film or one or more sheets of paper impregnated with resin and used as face material, mainly over plywood but also on lumber or other products. Overlays can be classified as masking, decorative, or structural, depending on their purpose.
- Parallel beating.**—Electric or high-frequency field parallel to adhesive joints.
- Particleboard.**—A generic term for a panel manufactured from lignocellulosic materials—commonly wood—in the form of particles (as distinct from fibers) which are bonded together with a synthetic binder (or other) under heat and pressure by a process wherein the interparticle bonds are created wholly by the added binder.
- Pearl glue.**—Animal glue dried in the form of round pearls.
- Pitch.**—In finger joints, the distance between midpoint of one fingertip and the midpoint of the adjacent fingertip.
- Pith side.**—Side nearest to pith (and usually center of tree).
- Planer.**—Machine equipped with cutter rolls and feed rolls for surfacing or planing wood.
- Plasticizer.**—A liquid or solid chemical added to a compound to impart softness or flexibility, or both, to it.
- Platens.**—Steel plates constituting the pressure elements in a single- or multi-opening hot press.
- Plywood.**—A composite product made up of crossbanded layers of veneer only or veneer in combination with a core of lumber or of particleboard bonded with an adhesive. Generally the grain of adjacent plies is roughly at right angles and an odd number of plies is usually used.
- Pneumatic.**—Filled with compressed air.
- Polymerization.**—A chemical reaction in which the molecules of a monomer are linked together to form large molecules whose molecular weight is a multiple of that of the original substance. When two or more monomers are involved, the process is called copolymerization or heteropolymerization.
- Polyurethane.**—A versatile chemical used for adhesives, sealing compounds, finishes, and other purposes.
- Porosity.**—The ratio of the volume of a material's pores to that of its solid content.
- Pot life.**—Usable life of adhesive after mixing (see also *Working life*).
- Precipitated.**—Separated out (addition of acid to milk causes curds to separate out from whey).
- Precuring.**—Condition of too much cure or set of the glue before pressure is applied, resulting in inadequate flow and glue bond.
- Prefabricated.**—Factory-built, standardized sections or components for shipment and quick assembly, as for a house.

- Preservative.**—Any substance that, for a reasonable length of time, is effective in preventing the development and action of wood-destroying fungi, borers of various kinds, and harmful insects that deteriorate wood when the wood has been properly coated or impregnated with it.
- Quartersawed.**—Sawn so the annual rings are essentially perpendicular to the wide face of the board. Lumber is considered quartersawed when the annual growth rings form an angle of 45° to 90° with the wide surface of the piece.
- Rabbet.**—A type of joint for fitting one wood member to another (for example, planking to keel and stem of a boat).
- Racking.**—Application of pressure to the end of a wall anchored at the base but free to move at top.
- Radiofrequency energy.**—Electrical energy produced by electric fields alternating at radiofrequencies.
- Rail.**—Bottom or top horizontal member of a door.
- Reaction wood.**—Common term for tension wood in hardwoods and compression wood in softwoods.
- Reactive.**—Adhesives that cure *or* set rather fast (opposite to sluggish or slow curing).
- Reconditioned.**—Brought back to a previous condition (for example, previous moisture level).
- Relative humidity.**—Ratio of the amount of water vapor present in the air to that which the air would hold at saturation at the same temperature. It is usually considered on the basis of the weight of the vapor but, for accuracy, should be considered on the basis of vapor pressures.
- Rennet**—A preparation or extract used to curdle milk (as in cheesemaking).
- Resiliency.**—The quality of being resilient or elastic.
- Resin.**—A solid, semisolid, or pseudosolid organic material that has an indefinite and often high molecular weight, exhibits a tendency to flow when subjected to stress, usually has a softening or melting range, and usually fractures conchoidally.
- Resurfacing.**—Planing again to obtain a freshly clean surface for gluing.
- Ribbon spreading.**—Spreading a glue in parallel ribbons instead of a uniform film.
- Roll coating.**—Application of a film of a liquid material (liquid resin) on a surface with rolls.
- Roller mill.**—Device for crushing beans by passing them between smooth rolls, thereby separating oil.
- Room-temperature-setting adhesive.**—An adhesive that sets at temperatures between 20° and 30° C. (68° to 86° F.)—the limits for standard room temperature specified in ASTM D 618.
- Rotary cut.**—Veneer cut on a lathe which rotates a log or bolt, chucked in the center, against a fixed knife.
- Sandwich panel.**—A layered construction comprising a combination of relatively high-strength, thin, facing materials intimately bonded to and acting integrally with a low-density core material.
- Sapwood.**—The living wood of pale color near the outside of the log. Under most conditions the sapwood is more susceptible to decay than heartwood.
- Sash.**—A frame for holding the glass pane or panes for a window.
- Scarf joints.**—Sloping joint between ends of two wood members.
- Setting.**—Hardening (see also *Curing*).
- Severe exposure.**—Exposure to harsh weather conditions or to harsh tests such as boiling and drying at low humidities.
- Shear.**—The relative displacement of woody tissues following fracture as a result of shearing stress.
- Shear block test** (also called *glue block shear test*).—A means of testing a glue joint in shear (ASTM D 905).
- Shear parallel to grain.**—Stresses applied in a manner to cause shear failure along the grain.
- Shear strength.**—The capacity of a body to resist shearing stress.

- Shoe (Tapeless splicer).**—Device for bonding veneers edge to edge with glue (no tape).
- Short grain.**—Term used for cross grain as when end grain is exposed on face of veneer.
- Showthrough.**—Term used when effects of defects within a panel can be seen on the face.
- Sizing.**—The process of applying diluted animal glue or similar material to the face or faces of a panel to reinforce fuzzy fibers and facilitate sanding.
- Skinning.**—Formation of a skin on the adhesive surface due to evaporation of solvent.
- Sliced veneer.**—Veneer that is sliced off a log, bolt, or flitch with a knife.
- Slip joint.**—Type of corner joint with interlocking “fingers.”
- Slope of grain.**—Angle between grain direction and axis of piece.
- Soak-dry cycles.**—Type of test where specimens are alternately soaked and dried.
- Softwood.**—A conventional term for both timber and the trees belonging to the botanical group Gymnospermae.
- Solids content.**—The percentage by weight of the nonvolatile matter in an adhesive.
- Solid core.**—Core with no open spaces as occur in hollow cores.
- Solvent.**—The medium within which a substance is dissolved, most commonly applied to liquids. Used to bring particular solids into solution.
- Spar.**—Round wood member used on ships for loading and unloading, also for keeping sails outstretched.
- Spat-flange.**—Upper or lower member of a spar made in the form of an I-beam.
- Specific adhesion.**—Adhesion effected by valence forces (of the same type as those that effect cohesion) acting between the adhesive and the adherend.
- Specific gravity.**—In wood technology, the ratio of the oven-dry weight of a piece of wood to the weight of an equal volume of water at 4° C. (39° F.). Specific gravity of wood is usually based on the green volume.
- Spline.**—Thin piece of wood or plywood often used to reinforce a joint between two pieces of wood.
- Spray dried.**—Dried under vacuum of atomized particles of a liquid resin.
- Squeezeout.**—Bead of glue squeezed out of a joint when gluing pressure is applied.
- Starved joint.**—A joint that is poorly bonded because insufficient adhesive has remained in it as a result of excessive pressure on the joint or too low viscosity, or both; the adhesive is forced out from between the surfaces to be joined.
- Stem.**—Continuation of the keel to form the prow of a boat or ship.
- Stiles.**—Vertical pieces in a panel or frame, as of a door or window.
- Storage life.**—The period of time during which a packaged adhesive can be stored under specified temperature conditions and remain suitable for use. Sometimes called shelf life.
- Straight-grained wood.**—Wood in which the fibers run parallel to the axis of the piece.
- Stress.**—The force (per unit area) developed in resistance to loading or, under certain conditions, self-generated in the piece by internal variations of moisture content, temperature, or both.
- Stress risers.**—Points of concentrated stress.
- Structural plywood.**—Plywood for structural use, such as flooring, siding, and roof sheathing.
- Stud.**—One of a series of slender, vertical structural members placed as supporting elements in walls and partitions.
- Sunken joint.**—Depression in wood surface at glue joint caused by surfacing edge-glued material too soon after gluing. (Inadequate time allowed for moisture added with glue to diffuse away from the joint.)
- Synthetic adhesives.**—Adhesives produced by chemical synthesis.

- Tuck.**—The property of an adhesive that enables it to form a bond of measurable strength immediately after adhesive and adherend are brought into contact under low pressure.
- Tapeless splicer.**—Machine for joining veneers edge to edge with glue only and no tape.
- Tenon.**—A projecting part cut on the end of a piece of wood for insertion into a corresponding hole in another piece to make a joint.
- Tensile strength.**—The capacity of a body to sustain tensile loading (resistance to lengthwise stress). In wood, tensile strength is high along the grain and low across the grain.
- Tension parallel to grain.**—Stress on a material (wood) in the long direction of its fibers.
- Tension wood.**—An abnormal form of wood found in leaning trees of some hardwood species and characterized by the presence of gelatinous fibers and excessive longitudinal shrinkage. Tension wood fibers hold together tenaciously, so that sawed surfaces usually have projecting fibers and planed surfaces often are torn or have raised grain. Tension wood may cause warping.
- Texture.**—The arrangement of the particles or constituent parts of material, such as wood, metal, etc. (Uniformly textured wood—not a great difference between earlywood and latewood.)
- Thermal softening.**—Softens with heat.
- Thermoplastic.**—Softens or becomes plastic with sufficient heat.
- Thixotropy.**—A property of adhesive systems to thin upon isothermal agitation and to thicken upon subsequent rest.
- Tongue-and-groove.**—A kind of joint in which a tongue or rib on one board fits into a groove on another.
- Tooth planing.**—Planing resulting in a ridged or toothed surface which was thought to give a better anchorage for glue than a smooth surface.
- Torque wrench.**—Wrench equipped with indicating device for measuring torque.
- Transverse section.**—Wood cut in a direction perpendicular to the grain, producing an end-grain surface.
- Treating cylinder.**—Cylindrical-shaped vessel equipped with vacuum and pressure pumps used in preservative pressure treatment of wood.
- Truss.**—A frame or jointed structure designed to act as a beam of long span, while each member is usually subjected to longitudinal stress only, either tension or compression.
- Twist.**—A distortion caused by the turning or winding of the edges of a board so that the four corners of any face are no longer in the same plane.
- Uncatalyzed.**—No catalyst employed or added.
- Underlayment.**—A material placed under finish coverings, such as flooring or shingles, to provide a smooth, even surface for applying the finish.
- Vacuum molding.**—Process of molding a thin plywood or laminate to desired shape by use of rubber bag, etc., from which air can be evacuated.
- Vacuum pressure.**—Term describing process of applying vacuum and pressure alternately.
- Varnish.**—A thickened preparation of drying oil or drying oil and resin suitable for spreading on surfaces to form continuous, transparent coatings or for mixing with pigments to make enamels.
- Veneer.**—Thin sheets of wood made by rotary cutting or slicing of a log.
- Veneer clipper.**—Machine for cutting veneers into desired sizes.
- Viscosity.**—That property of a fluid material by virtue of which, when flow occurs inside it, forces arise in such a direction as to oppose flow.
- Waterborne chemical.**—In wood preserving, a chemical dissolved in water to facilitate penetration into wood.
- Water soluble.**—Substance that can be dissolved in water.

Weathering.—The mechanical or chemical disintegration of the surface of wood that is caused by exposure to light, the action of dust and sand carried by winds, and the alternate shrinking and swelling of the surface fibers with continual variation in moisture content brought by changes in the weather. Weathering does not include decay.

Wet-bulb temperature.—The temperature indicated by any temperature-measuring device, the sensitive element of which is covered by a smooth, clean, soft, water-saturated cloth (wet-bulb wick).

Wet joint strength.—Shear stress resisted by joints after exposure to water soaking or in wet condition.

Whey.—The thin, watery part of milk which separates from the thicker parts

(curds) after coagulation, as in cheese-making.

Wood failure.—The rupturing of wood fibers in strength tests on bonded specimens, usually expressed as the percentage of the total area involved which shows such failure.

Wood flour.—Very finely divided wood, as produced by grinding in a ball mill. It is graded according to the mesh it must pass.

Working life.—The period of time during which an adhesive, after mixing with catalyst, solvent, or other compounding ingredients, remains suitable for use.

Zinc white.—Zinc oxide used as a pigment.

Zone of char.—Zone burned to a char (*see also Char*).

INDEX

- Acid-catalyzed phenol resin adhesives 14, 93
- Adjustments in adhesives and gluing procedures 96
- Alkaline phenol resins 13, 65, 93
- Animal glue 27
 - Durability 28
 - Mixing 27
 - Used at room temperature.... 92
 - Used in furniture manufacture . 71
- Assembly time 90, 109
 - Closed assembly 87, 90, 109
 - For animal glues 28
 - For phenol resin adhesives..... 13
 - For resorcinol resins 15
 - For room-temperature-setting urea resins 19
 - Open assembly 87, 90, 109, 115
- Bag molding 14, 109
- Blood glue 33, 65
- Bonding dense woods 98
- Bonding laminated timbers 69, 97
- Bonding light, porous species 98
- Bonding plywood 65
- Butt joint 49, 110
- Calking gun 82, 89
- Casein glues 29
 - Durability 31, 32
 - Formulation 29
 - Preparation 29
 - Prepared 30
 - Use characteristics 30
 - Used for furniture bonding 71
 - Used for laminated timbers ... 69
 - Wet-mixed casein glue 30
- Causes and prevention of warping . 40
- Causes of plywood cupping . . . 41
- Circular tongue-and-groove edge joint 61
- Clamping glue joints 91
- Closed assembly 87, 90, 109
- Conditioning glued products 96
- Contact adhesives 26, 85
- Corner joints 49
- Crossbanded construction 36
- Cupping of plywood 41
- Curing adhesives 92
 - Elevated temperature curing .. 92, 93
 - Equipment 93, 94
 - Hot-setting ureas 92
 - Low voltage heating 83
 - Melamines 92
- Curing temperatures for adhesives 77
 - Acid phenolic glues 13
 - Alkaline phenol resins..... 13
 - Blood glues 33
 - Intermediate-temperature-setting phenol resins 14
 - Melamine resin adhesives . . . 21
 - Resorcinolresins 15
 - Thermosetting polyvinyl emulsions 24
 - Urea resin adhesives 18
- Cutting and preparing veneer 62
- Density 4, 111
- Double spreading 89, 111
- Dovetail edge joint 62
- Drying lumber 58
- Drying veneer 58
- Durability of
 - Alkaline phenol resins 16
 - Animal glue joints 28
 - Casein joints 31, 32
 - Melamine resins 22
 - Phenol resorcinol resins 16
 - Polyvinyl resin emulsions 24
 - Resorcinolresins 16
 - Urea resins 17, 19, 20
- Durability of synthetic adhesives 10, 24
- Edge gluing 35, 63, 111
- Elevated temperature curing of glue 92
- End-joint gluing 35, 112
 - Circular tongue-and-groove 61
 - Dado 62
 - Dovetail 62
 - Mortise-and-tenon 62
 - Plain 62
 - Rabbet 62
 - Slip 62
 - Tongue-and-groove 62
- End and corner joint construction 49, 50
- Epoxy resin adhesives 25, 81
- Extenders used in synthetic adhesives 10, 112
- Extruders used in applying adhesives 89
- Factors affecting gluing 2
 - Assembly time 2
 - Pressure 2
 - Temperature 2

Figured veneer	39, 112	Machine marks on lumber	60
Filletts used in synthetic adhesives	10, 13, 112	Machining special types of joints	62
Finger joints	18, 51, 94, 112	End-grain surfaces	62
Flush doors	79	End-to-side-grainsurfaces	62
Fortifiers	18, 112	Side-grainsurfaces	61
Furniture	70	Marine plywood	77, 114
Glues used	29, 72, 73	Masticadhesives	26, 82, 114
Species used	70	Melamine resin adhesives	21, 22
Gluability test	2	Melamine urea resins	22, 74, 81, 92, 95, 102
Glue block shear test	116	Mixing adhesives	87, 88
Gluing doors	79	Moisture content of wood	56
Gluing hardwood plywood	67	At time of gluing	56
Gluing housing and housing components	82, 83	Gluing furniture	56
Gluing jewelry	84	Gluing hardwood plywood	67
Gluing laminated flooring	84	Gluing lumber	58
Gluing operations	87	Gluing veneer	58
Applying gluing pressure	91	In service	56
Assembling parts	90	Using casein glue	30
Assembly time	90	Nail gluing	82, 83
Conditioning glued stock	96	Natural origin adhesives	27
Mixing	87	Animal	27, 73
Spreading	88	Blood	33
Gluing particleboard	81	Casein	29
Gluing preservative-treated wood	99	soybean	32
Treated with fire-retardant chemicals	101	Open assembly	87, 115
Treated with oil-soluble preservatives	101	Overlay	115
Treated with resorcinol-resin adhesives	17	Overlays bonded to wood	85
Treated with waterborne preservatives	101	Pearl glue	115
Gluing pressure	91	Phenol-formaldehyde adhesives	13
Gluing spotting goods	81	Phenol resins	11, 65
Gluing treated wood	98	Phenol-resorcinol resins	15, 16, 72, 77, 80, 84, 92, 95, 101
Gluing untreated wood	101	Plain edge joint	61
Gluing woods treated with oil-soluble preservatives	101	Plywood advantages vs. solid wood construction	36
Gluing woods treated with waterborne preservatives	101	Plywood construction	36, 38
Hardener for synthetic adhesives	10	Requirements	43
Hardwood plywood	67	Species preferred	46
Construction	67	Plywood cores	43
Moisture content when gluing	67	Requirements	43
High-frequency heating	18, 74, 94, 113	Polyvinyl resin emulsions	22, 23, 73, 89, 92
Hot-melt adhesives	21, 25, 63, 74	Pot life	115
Hot-press urea resin adhesives	18, 92	For epoxy adhesives	26
Intermediate-temperature-setting phenol resins	14	For melamine resin adhesives	22
Jig	83, 113	Preparing wood for gluing	56
Laminated construction	45	Pressing and curing glue joints	83
Bonding	69	Pressing or clamping	91
Properties	45	Properties important in bonding	4
Selection of species and grades	46	Quality control	102
Stresses in	47	Tension tests	106
Uses	45	Vacuum-pressure, soak-dry tests	106
Laminated flooring	84	Rate of curing or setting	10, 11
Laminated ship and boat members	76	Requirements for crossbands	43
		Resorcinol-resin adhesives	14, 16, 72, 78, 83, 84, 93, 95, 101, 102
		Ribbon spreading	116

Room-temperature-setting urea resins	17, 92, 116	Sunken joints	96
Rotary-cut veneer	62, 63	Surfacing wood for gluing	60
Scarf joints	49, 116	Synthetic adhesives	10
Serrated scarf joint	62	Advantages	10
Shear block test	116	Durability	10
Ship and boat construction	76	Melamines	21, 22
Adhesives used	77	Phenols	13
Gluing operations	77	Polyvinyls	22, 23
Species desired	46	Resorcinols	14, 15, 24
Use of melamine resin glues	21	Ureas	17, 18, 19, 72
Use of resorcinol resins	15	Used in manufacturing	10
Shrinking and swelling	7	Tenon	118
Sliced and sawed veneers	63	Thermosetting polyvinyl emulsions	23, 73
Softwood plywood	65	Tongue-and-groove	61, 118
Exterior	65	Twisting of plywood	40
Interior	65	Urea-formaldehyde resin adhesives	17, 18, 19, 20, 72, 81, 84, 92
Uses	67	Vacuum molding	118
Solid cores for flush doors	79	Vinyl overlays	85
Soybean glue	27, 32, 65	Warping, causes and prevention	40
Spreading adhesives	88	Wood "jewelry"	84
Starved glue joint	90, 117		
Storage of lumber	59		
Storage of veneer	60		
Stress relief in laminated construction	49		